

CT-8000 S3 DIGITAL CIRCUIT BREAKER ANALYZER

USER'S MANUAL



Vanguard Instruments Company, Inc.

1520 S. Hellman Ave.

Ontario, California 91761, USA

TEL: (909) 923-9390
FAX: (909) 923-9391

October 2013
Revision 1

SAFETY SUMMARY

FOLLOW EXACT OPERATING PROCEDURES

Any deviation from the procedures described in this User's Manual may create one or more safety hazards, may damage the CT-8000 S3, or cause errors in the test results. Vanguard Instruments Company, Inc. assumes no liability for unsafe or improper use of the CT-8000 S3.

All safety precautions provided in this manual must be observed during all phases of testing including test preparation, test lead connection, actual testing, and test lead disconnection.

SAFETY WARNINGS AND CAUTIONS

Only trained operators shall use the CT-8000 S3. All devices under test shall be **off-line** and **fully isolated**. Do not perform test procedures or service unless another person is also present who is capable of rendering aid and resuscitation.

DO NOT MODIFY TEST EQUIPMENT

To avoid the risk of introducing additional or unknown hazards, do not install substitute parts or perform any unauthorized modification to any CT-8000 S3 test unit. To ensure that all designed safety features are maintained, it is highly recommended that repairs be performed only by Vanguard Instruments Company factory personnel or by an authorized repair service provider. Unauthorized modifications can cause safety hazards and will void the manufacturer's warranty.

WARNING

Do not remove test leads during a test. Failure to heed this warning can result in electrical shock to personnel and damage to the equipment.

TABLE OF CONTENTS

CONVENTIONS USED IN THIS DOCUMENT	1
1.0 INTRODUCTION	2
1.1 General Description and Features	2
1.2 Optional Features	4
1.3 Technical Specifications	5
1.4 CT-8000 S3 Controls and Indicators	6
2.0 PRE-TEST SETUP	8
2.1 LCD Screen Contrast Control.....	8
2.2 Printer Paper Control	8
2.3 Printer Paper	8
3.0 OPERATING PROCEDURES	10
3.1 Cable Connections	10
3.1.1. Contact Cable Connections	10
3.1.2. Initiate Cable Connections	12
3.1.3. Dynamic Resistance Test Connections	14
3.1.4. Online Timing Connections (with optional Online Timing feature)	15
3.1.5. Dual Ground Connections (with optional Dual Ground feature)	17
3.1.6. Analog and Digital Voltage Monitoring Connections	18
3.1.7. External Trigger Input Connections.....	19
3.1.8. Digital Transducer Connection	20
3.1.9. Resistor Type Transducer Connection.....	21
3.2 Changing Setup Parameters.....	22
3.2.1. Entering Test Record Header Information	22
3.2.2. Setting the Clock.....	25
3.2.3. Configuring Automatic or Manual Printing of Test Results.....	26
3.2.4. Setting the Units of Measure	27
3.2.5. Setting the OPEN Timing Analysis Points	28
3.2.6. Selecting the Contact Cycle Reading Frequency	31
3.2.7. Configuring the Channel Settings.....	35
3.2.8. Configuring the Contact Filter Settings	37
3.2.9. Configuring the Transducer Encoder Filter Setting.....	39
3.2.10. Configuring the Digital Rotary Transducer Settings	41
3.2.11. Configuring the Resistor Type Transducer Settings	43
3.3 Performing Circuit Breaker Timing Tests	51
3.3.1. Timing an OPEN Operation.....	52
3.3.2. Timing a CLOSE-OPEN Operation	55
3.3.3. Timing an OPEN-CLOSE-OPEN Operation.....	59
3.3.5. Performing a Static Resistance Test	68
3.3.6. Performing a Dynamic Resistance Test	70
3.3.7. Printing or Viewing Timing Results.....	74
3.4 Working with Test Records	85
3.4.1. Saving a Timing Record in Flash EEPROM	85

- 3.4.2. Printing a Directory of Test Records Stored in the CT-8000 S3's Memory 86
- 3.4.3. Printing a Directory of Test Records Stored in a USB Flash Drive 88
- 3.4.4. Recalling a Test Record from the Flash EEPROM 89
- 3.4.5. Restoring a Test Record from a USB Flash Drive..... 91
- 3.4.6. Copying Test Records to a USB Flash Drive 93
- 3.4.7. Deleting Test Records from the Flash EEPROM 95
- 3.4.8. Deleting Test Records from a USB Flash Drive 98
- 3.5 Working With Test Plans..... 101
 - 3.5.1. Recalling a Breaker Test Plan for Use..... 101
 - 3.5.2. Printing a Directory of Test Plans Stored in the CT-8000 S3's Memory..... 104
 - 3.5.3. Printing a Directory of Test Plans Stored in a USB Flash Drive 106
 - 3.5.4. Printing a Breaker Test Plan Stored in the CT-8000's Memory..... 108
 - 3.5.5. Printing a Breaker Test Plan Stored in a USB Flash Drive..... 110
 - 3.5.6. Copying a Test Plan to a USB Flash drive 112
- 4.0 DIAGNOSTICS, VERIFICATION, AND TROUBLESHOOTING 117
 - 4.1 Performing a Slow-Close Test 117
 - 4.2 Performing a Transducer Self-Test 119
 - 4.3 Testing the Cable Hookups 121
 - 4.4 Printing Raw Test Record Data 123
 - 4.5 Troubleshooting Guide 125
- 5.0 APPENDICES 127
 - 5.1 APPENDIX A – ITE Model 14.4K Circuit Breaker Timing Charts and Reports..... 127
 - 5.2 APPENDIX B – Siemens TCP Breaker Velocity Calculation 132
 - 5.3 APPENDIX C – Siemens SPS2 Breaker Velocity Calculation 133
 - 5.4 APPENDIX D – CT-8000 S3 Test Plan for Siemens SPS2 134
 - 5.5 APPENDIX E – CT-8000 S3 Transducer Illustrations 135
 - 5.6 APPENDIX F – CT-8000 S3 Accessories..... 138

LIST OF TABLES

- Table 1. CT-8000 S3 Technical Specifications 5
- Table 2. Functional Descriptions of CT-8000 S3 Controls and Indicators..... 7
- Table 3. Descriptions of Tabulated Test Results Elements..... 78

LIST OF FIGURES

Figure 1. CT-8000 S3 Controls and Indicators.....	6
Figure 2. Typical 3-Phase Circuit Breaker Connections	10
Figure 3. Typical Connections for Series Contact Circuit Breaker	11
Figure 4. Typical DC Trip and DC Close Control Circuit Connection	12
Figure 5. Typical DC Trip and AC Close Control Circuit Connection.....	13
Figure 6. Typical Dynamic Resistance Test Connections	14
Figure 7. On-line Timing Probe Set (Part No. 9021-OT).....	15
Figure 8. Typical Connections for Optional On-line Timing Mode	16
Figure 9. Typical Connections for Optional Dual Ground Testing Mode.....	17
Figure 10. Typical Analog and Digital Voltage Monitoring Connections	18
Figure 11. Typical External Trigger Input Cable Connections	19
Figure 12. Typical Digital Transducer Connection	20
Figure 13. Typical Resistor Type Transducer Connection.....	21
Figure 14. Typical 50 Hz Tabulated Test Results.....	34
Figure 15. Typical 60 Hz Tabulated Test Results.....	34
Figure 16. Contact Filter Setting Illustrations	38
Figure 17. Sample Resistor Type Transducer Setup Directory	49
Figure 18. Sample Timing Report Using a Resistor Type Transducer	50
Figure 19. Typical O-C-O Test Results Graph	64
Figure 20. Typical Tabulated Test Results Printout for an O-C-O Operation.....	65
Figure 21. Typical On-Line Timing Test Graph Printout.....	66
Figure 22. Typical On-Line Timing Test Results Printout.....	67
Figure 23. Typical Static Resistance Test Report	69
Figure 24. Dynamic Resistance Graph (0 - 400 micro-ohm linear scale).....	72
Figure 25. Dynamic Resistance Graph (0 - 2000 micro-ohm linear scale).....	73
Figure 26. Dynamic Resistance Graph in Semi-Log Scale	73
Figure 27. Typical Tabulated Test Results Printout for a CLOSE Operation	77
Figure 28. Typical Test Results Graph (CB CLOSE Test)	79
Figure 29. Expansion Graph from 0ms to 200ms (CB CLOSE Test).....	80
Figure 30. Typical O-C-O Test Results Graph	81
Figure 31. Typical Tabulated Test Results Printout for an O-C-O Operation.....	82
Figure 32. Graphical Interpretation of an OPEN Timing Shot.....	83
Figure 33. Graphical Interpretation of a CLOSE Timing Shot.....	83
Figure 34. Graphical Interpretations of an OPEN-CLOSE and CLOSE-OPEN Timing Shot.....	84
Figure 35. Sample Test Record Directory Printout	87
Figure 36. Typical Test Results Printout with Pass/Fail Indicators	103
Figure 37. Typical Test Plan Directory Printout	105
Figure 38. Typical Breaker Test Plan Printout.....	114
Figure 39. Siemens SPS2 121 CLOSE Timing Illustration.....	115
Figure 40. Siemens SPS2 121 OPEN Timing Illustration.....	116
Figure 41. Typical Slow-Close Test Results Printout	118
Figure 42. Partial Data Points Printout	124

CONVENTIONS USED IN THIS DOCUMENT

This document uses the following conventions:

- A key or switch on the CT-8000 S3 is indicated as **[KEY]** and **[SWITCH]**.
- Menu options are referenced as (MENU OPTION).
- Screen and menu names are referenced as "SCREEN/MENU NAME".
- The terms "test record" and "test shot" are used interchangeably.
- CT-8000 S3 LCD screen output is shown as:

```
1. OPTION 1
2. OPTION 2
3. OPTION 3
4. OPTION 4
5. OPTION 5
```

- When instructions are provided, the menu item that should be selected is shown in **bold** as shown below (option 3 should be selected):

```
1. OPTION 1
2. OPTION 2
3. OPTION 3
4. OPTION 4
5. OPTION 5
```

- Warning messages are indicated as:



- Important notes are indicated as:

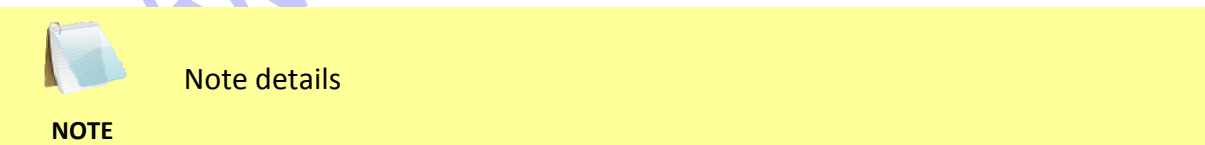

1.0 INTRODUCTION

1.1 General Description and Features

The CT-8000 S3 is Vanguard's fourth generation EHV circuit breaker analyzer. The CT-8000 S3 is available with 3 (part number 9103-UC) or 6 contact timing channels (part number 9104-UC). The CT-8000 S3 can fully analyze a circuit breaker's performance by measuring the main contact and resistor contact time, stroke, velocity, over-travel, bounce back and contact wipes. Also, an outstanding feature of the CT-8000 S3 is the ability to perform dynamic resistance tests on circuit breaker contacts.

Dynamic Contact Resistance Test

The CT-8000 S3 can perform dynamic-resistance tests using a 200-ampere, built-in, DC power supply. One channel is available for performing a dynamic contact resistance test. The resistance measuring range is from 1 micro-ohm to 1,999 micro-ohms. The resistance chart can be used to analyze the circuit-breaker contact condition during the CB operation. This important feature can help detect circuit-breaker contact erosion or other contact problems that cannot be detected in static resistance tests. The CT-8000 S3 can also be used as a 200-ampere micro-ohmmeter to test circuit-breaker contact resistance and bus connections, or can be used for other applications where a low-resistance measurement is required.

Contact Timing Input Channels

The CT-8000 S3's dry contact timing channels (up to 6 channels) are used to time the circuit breaker main contacts. Each main contact timing channel is capable of detecting the main contact and insertion resistor contact time. Timing results are displayed in milliseconds and cycles. The CT-8000 S3's timing window is selectable between 1 second, 10 seconds, and 20 seconds.

Resistor Type Transducer Inputs

The CT-8000 S3 offers 3 resistor type transducer input channels. These input channels are used to interface with any resistor-type transducers to monitor the circuit breaker motion. Transducer resistance ranges from 200 Ohms to 10K Ohms.

Breaker Stroke and Velocity

Three dedicated digital travel transducer channels are available on the CT-8000 S3 for measuring circuit-breaker contact stroke, velocity, over-travel, and bounce back. With the use of the Vanguard digital travel transducers, neither calibration nor setting is required. Circuit breaker contact velocity is calculated based on contact's travel distance over a period of time. Special formulas to calculate velocity is also accommodated by the CT-8000 S3. Special feature is also available to "Slow-Close" test the circuit breaker and obtain a test result report.

Voltage Monitoring Channels

The CT-8000 S3 features three voltage monitoring input channels (V1, V2, and V3). The V1 voltage channel is dedicated to monitoring the substation DC supply or coil voltage (0-255 V, DC or peak AC). The nominal and minimum DC supply voltage levels are recorded and printed on the tabulated report. An analog waveform showing the DC power supply is plotted on the graphical report. The two digital voltage input channels, V2 and V3, are dedicated to monitoring voltage on/off status presence or absence of the circuit breaker auxiliary switches. Digital waveforms showing V2 and V3 activity are plotted on the graphical report. Three timing events of the V2 and V3 activities are recorded and printed on the tabulated report.

Breaker Initiate Features

A built-in solid-state initiate device is used to operate a breaker from the CT-8000 S3. Operational modes include OPEN, CLOSE, OPEN-CLOSE, CLOSE-OPEN, and OPEN-CLOSE-OPEN. Multiple operation like OPEN-CLOSE, CLOSE-OPEN, and OPEN-CLOSE-OPEN can be initiated by using a programmable delay time (in milliseconds) or by sensing a specific breaker contact condition.

OPEN/CLOSE Coil Current Monitoring

One built-in, hall-effect sensor records the OPEN/CLOSE coil current amplitude and waveform. The circuit breaker's coil current waveform, effectively, a coil performance "fingerprint" or "current profile", can be used as a diagnostic tool for analyzing the circuit breaker's performance.

Computer Interface

The CT-8000 S3 can be computer-controlled via the USB or optional Bluetooth interface. Windows-based Circuit Breaker Analysis Software is provided with each unit. Using this software, circuit breakers can be timed from the PC. Test records can be retrieved from the CT-8000 S3 and then stored on the PC for future analysis and report generation. Circuit breaker test plans can also be created on the PC and transferred to the CT-8000 S3. Additionally, test records can be automatically exported in Excel, PDF, and XML formats.

Built-in Thermal Printer

The CT-8000 S3's built-in 4.5" wide thermal printer can print the breaker contact analysis results in both tabular and graphic formats.

User Interface

The CT-8000 S3 features a back-lit graphic LCD screen (240 x 128 pixels) that is viewable in direct sunlight and low-light levels. A rugged 44-key "QWERTY"-style membrane keypad is used to control the unit and input information.

Internal Test Record and Test Plan Storage

The CT-8000 S3 uses Flash memory to store up to 200 test records internally. Test records can be recalled and printed on the unit's built-in 4.5" wide thermal printer. Test records can also be transferred to a USB Flash drive or exported to a PC via the USB port or Bluetooth (optional) with the included Windows-based software.

Up to 100 circuit breaker test plans can be stored in the CT-8000 S3's Flash memory. A test plan is comprised of all circuit breaker performance specifications (contact time, stroke, velocity, etc.). When a test plan is used with a timing test, a Pass/Fail report is generated by comparing the actual performance with the specifications in the stored test plan. Test plans can be transferred to the CT-8000 S3 from a USB Flash drive, or from a PC via the USB port or Bluetooth (optional).

External Test Record and Test Plan Storage

A USB Flash drive can be used to store and transfer test plans and up to 999 test records.

Diagnostic Capabilities

The CT-8000 S3 can perform diagnostics on its internal electronics. Diagnostics can be performed to verify contact cable connections and to test the travel transducer's electronics.

1.2 Optional Features

“On-line” Timing Mode

In addition to the conventional off-line timing mode, the CT-8000 S3 also offers an optional three-phase “on-line” timing mode. In this mode, the CT-8000 S3 captures the breaker's trip or close time, the trip/close coil current “fingerprint,” and the battery supply voltage while the breaker is still in service. The trip/close time is derived from the time of trip, or close coil initiation, to the breaker's bushing current breaker-make as detected by a AC clamp-on current sensing probes. Trip/Close current waveforms are also captured by an external clamp-on DC current probe.

The “on-line” timing mode can detect a breaker's operating conditions with little or no down time. In this mode, the first trip operation time of the breaker is captured. If a breaker has been in service for a long period of time and sitting in close position, the first trip time of the breaker may be slow possibly due to a sticky mechanism. The “on-line” mode is very useful in such cases because traditional breaker timing may not detect this condition since several operations may have occurred before the first timing test is conducted.

Dual Ground Testing Mode

With the optional dual ground testing mode, the CT-8000 S3 can measure a CB contact time with ground being applied to both sides of the bushings. The clamp-on probe is connected to one side of the CB safety ground straps, and an AC signal is coupled to this strap. A sensor on the probe will detect a change in the induced AC signal when the CB contact is opened or closed.

Bluetooth Interface

The optional Bluetooth interface can be used to wirelessly connect the CT-8000 S3 with a PC.

1.3 Technical Specifications

Table 1. CT-8000 S3 Technical Specifications

<i>TYPE</i>	Portable circuit-breaker analyzer
<i>PHYSICAL SPECIFICATIONS</i>	16"W x 11"H x 14"D (40.6 cm x 29.9 cm x 35.6 cm); Weight: 22 lbs (9.98 kg)
<i>INPUT POWER</i>	100-240Vac, 10A, 50/60Hz
<i>DRY-CONTACT INPUTS</i>	3 channels (9103-UC) or 6 channels (9104-UC). Channel can detect the main contact and resistor contact time.
<i>TIMING WINDOWS</i>	1 second, 10 seconds, or 20 seconds
<i>TIMING RESOLUTIONS</i>	±50 micro-seconds @ 1 sec. duration, ±500 micro-seconds @ 10 sec. duration, ±1.0 milliseconds @ 20 sec. duration
<i>TIMING ACCURACY</i>	0.05% of reading ±0.05 ms @ 1 second duration
<i>DRY-CONTACT CHANNEL PROTECTION</i>	All contact inputs are grounded until test. Input channels are also protected against static discharge.
<i>DRY-CONTACT DETECTION RANGE</i>	Closed: Less than 20 Ohm. Opened: greater than 5000 ohm
<i>INSERTION RESISTOR DETECTION RANGE</i>	50 – 5,000 ohms
<i>TRIGGER INPUT VOLTAGE</i>	Open/Close trigger voltage: 24 V – 300V DC or peak AC
<i>VOLTAGE SENSING INPUT RANGE</i>	V1: analog input; 0 – 250 V DC or peak AC; sensitivity ±1 V; record and print voltage level V2 and V3: voltage presence/absence detector input; 24 – 255 V DC or peak AC; record and print 3 timing events
<i>BREAKER OPERATIONS</i>	Initiate Open, Close, Open-Close, Close-Open, Open-Close-Open
<i>BREAKER INITIATE CAPACITY</i>	30A, 250 Vac/dc max
<i>INITIATE CURRENT READING RANGE</i>	one, non-contact, Hall-effect sensor, 0 – 20 amp range, dc to 5 KHz AC
<i>DIGITAL TRAVEL TRANSDUCER INPUTS</i>	3 digital travel transducer channels; linear range: 0.0 – 60.0 in (±0.01 in) rotary range: 0 – 360 degrees (±0.36 degrees)
<i>RESISTOR TYPE TRANSDUCER INPUTS</i>	3 channels, 200 ohm – 10K ohms
<i>CONTACT TRAVEL POINT DIFFERENCE</i>	measures "slow-close" contact-point distances; results can be printed
<i>DYNAMIC/STATIC RESISTANCE RANGE</i>	0.1 – 1,999 micro-ohms; accuracy: ±2% of reading, ±5 micro-ohms
<i>RESISTANCE TEST CURRENT</i>	200 amperes max
<i>DISPLAY</i>	back-lit LCD screen (128 x 240 pixels); viewable in bright sunlight and low light
<i>PRINTER</i>	built-in 4.5" wide thermal printer that can print both graphic contact travel waveforms and tabulated test results
<i>INTERNAL TEST RECORD STORAGE</i>	Store up to 200 test records and 100 test plans
<i>EXTERNAL TEST RECORD STORAGE</i>	USB Flash drive interface for external storage of test records and test plans
<i>COMPUTER INTERFACES</i>	One USB port, optional Bluetooth wireless interface
<i>PC SOFTWARE</i>	Windows® based Breaker Analysis software included with purchase price
<i>CABLES</i>	furnished with full set of test leads
<i>OPTIONS</i>	transportation cases (available for the CT-8000 S3 and travel transducers), on-line timing mode, dual ground testing mode, Bluetooth interface
<i>SAFETY</i>	designed to meet UL 6101A-1 and CAN/CSA C22.2 No 1010.1-92 standards
<i>ENVIRONMENT</i>	Operating: -10°C to +50°C (+15°F to +122°F); Storage: -30°C to +70°C (-22°F to +158°F)
<i>HUMIDITY</i>	90% RH @ 40°C (104°F) non-condensing
<i>ALTITUDE</i>	2,000 m (6,562 ft) to full safety specifications
<i>WARRANTY</i>	one year on parts and labor



NOTE

The above specifications are valid at nominal operating voltage and at a temperature of 25°C (77°F). Specifications may change without prior notice.

1.4 CT-8000 S3 Controls and Indicators

The CT-8000 S3's controls and indicators are shown in Figure 1 below. A leader line with an index number points to each control and indicator, which is cross-referenced to a functional description in Table 2. The table describes the function of each item on the control panel. The purpose of the controls and indicators may seem obvious, but users should become familiar with them before using the CT-8000 S3. Accidental misuse of the controls will usually cause no serious harm. Users should also be familiar with the safety summary found on the front page of this User's Manual.

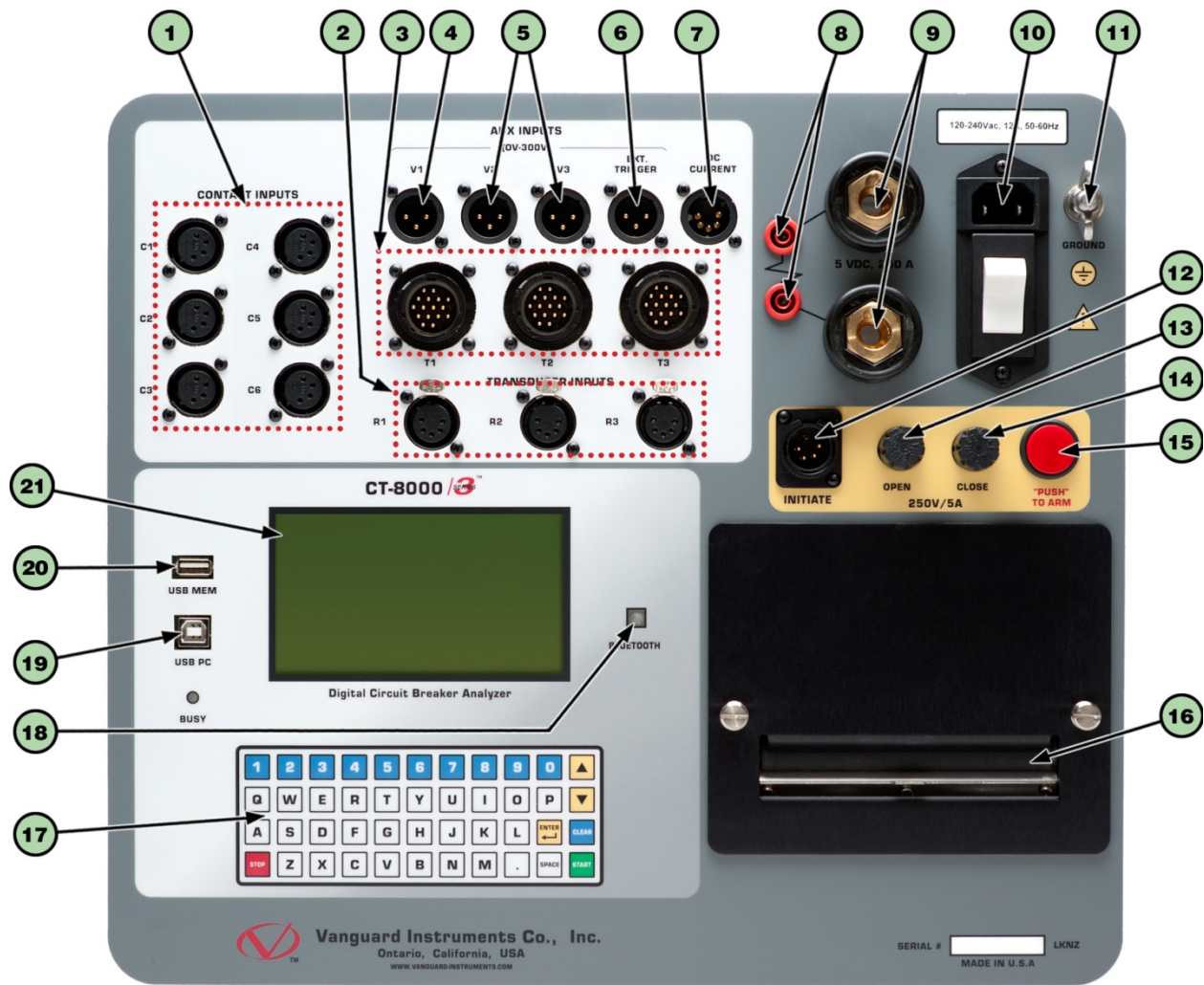

Figure 1. CT-8000 S3 Controls and Indicators

Table 2. Functional Descriptions of CT-8000 S3 Controls and Indicators

Item Number	Panel Markings	Functional Description
1	CONTACT INPUTS (C1-C6)	Female connectors for the contact channels. The CT-8000-6 S3 is pictured with 6 channels
2	R1, R2, R3	Resistor type transducer inputs
3	T1, T2, T3	Digital travel transducer channels
4	V1	V1 voltage input channel dedicated to monitoring circuit breaker DC power supply or coil voltages. Voltage sensing range is from 0-250 V DC or peak AC
5	V2, V3	V2 and V3 voltage input channels dedicated to detecting voltage absence or presence. Voltage input ranges from 24-255 V DC or peak AC. Each voltage channel records 3 timing events (voltage on/off) and the results are printed on the tabulated report
6	EXT. TRIGGER	Triggers voltage input for external trigger application. Voltage level ranges from 24 - 300 V DC or peak AC
7	DC CURRENT	External DC current probe connector
8		Micro-Ohmmeter sense inputs
9	5 VDC, 200A	200A Micro-Ohmmeter current output terminals
10	120-240Vac, 12A 50-60Hz	Power plug and switch
11	GROUND	Safety ground terminal
12	INITIATE	4-pin connector used for the switching circuit for operating the circuit breaker under test
13	OPEN 250V/5A	Open circuit fuse: 5 Ampere, 250V, Fast-Blow
14	CLOSE 250V/5A	Close circuit fuse: 5 Ampere, 250V, Fast-Blow
15	"PUSH TO ARM"	Spring-loaded pushbutton switch. Press and hold to complete the Trip or Close circuits for breaker tests
16		Built-in 4.5" wide thermal printer
17		Rugged "QWERTY" style membrane keypad
18	BLUETOOTH	Bluetooth status indicator (optional)
19	USB PC	USB computer interface port
20	USB MEM	USB Flash drive interface port
21		Back-lit LCD screen (128 x 240 pixels); viewable in bright sunlight and low light.

2.0 PRE-TEST SETUP

2.1 LCD Screen Contrast Control

To increase the LCD screen contrast, press and hold the **[▲]** key for two seconds. Release the button when the desired contrast level has been reached.

To decrease the LCD screen contrast, press and hold the **[▼]** key for two seconds. Release the button when the desired contrast level has been reached.

2.2 Printer Paper Control

To advance the thermal printer paper, press and release the **[▲]** key.

To retract the thermal printer paper, press and release the **[▼]** key.

2.3 Printer Paper

The CT-8000 S3's built-in thermal printer uses 4.5-inch wide thermal paper for printing test results. To maintain the highest print quality and to avoid paper jams, the use of thermal paper supplied by Vanguard Instruments Company is highly recommended. Additional paper can be ordered from the following sources:

Vanguard Instruments Co, Inc.

1520 S. Hellman Avenue
Ontario, CA 91761
Tel: 909-923-9390
Fax: 909-923-9391
Part Number: TP4-CS

BG Instrument Co.

13607 E. Trent Avenue
Spokane, WA 99216
Tel: 509-893-9881
Fax: 509-893-9803
Part Number: VIC TP-4 paper

2.4 Replacing the Thermal Printer Paper

The roll of thermal paper is housed inside a dispenser underneath the printer cover. To replace the paper, follow the steps below:

- Unscrew the two large printer cover screws and remove the printer cover.
- Remove the leftover thermal paper roll from the paper holder.
- Unroll the new thermal paper roll.
- Feed the thermal paper into the slot between the paper pocket and the rubber roller. The printer will automatically pull the paper under the thermal head.
- Place the paper roll into the paper holder.
- Lift the thermal head and align the thermal paper if necessary.
- Re-install the printer cover.

**NOTE**

Thermal paper has a chemical coating on one side of the paper. This side should be facing the thermal print head. Incorrect paper loading may result in blank output on the thermal paper.

The thermal paper will show a red stripe to indicate that the roll is about to run out of paper.

3.0 OPERATING PROCEDURES

3.1 Cable Connections

3.1.1. Contact Cable Connections

A typical contact cable connection to a circuit breaker is shown in Figure 2. Red and black clips are connected across the circuit contact phases A, B, and C. A typical circuit breaker with series contacts is shown in Figure 3.



NOTE

It is advisable to ground one side of the contacts for most testing purposes. If a breaker is floating or un-grounded, ensure that the contact channel inputs are protected against static discharge.

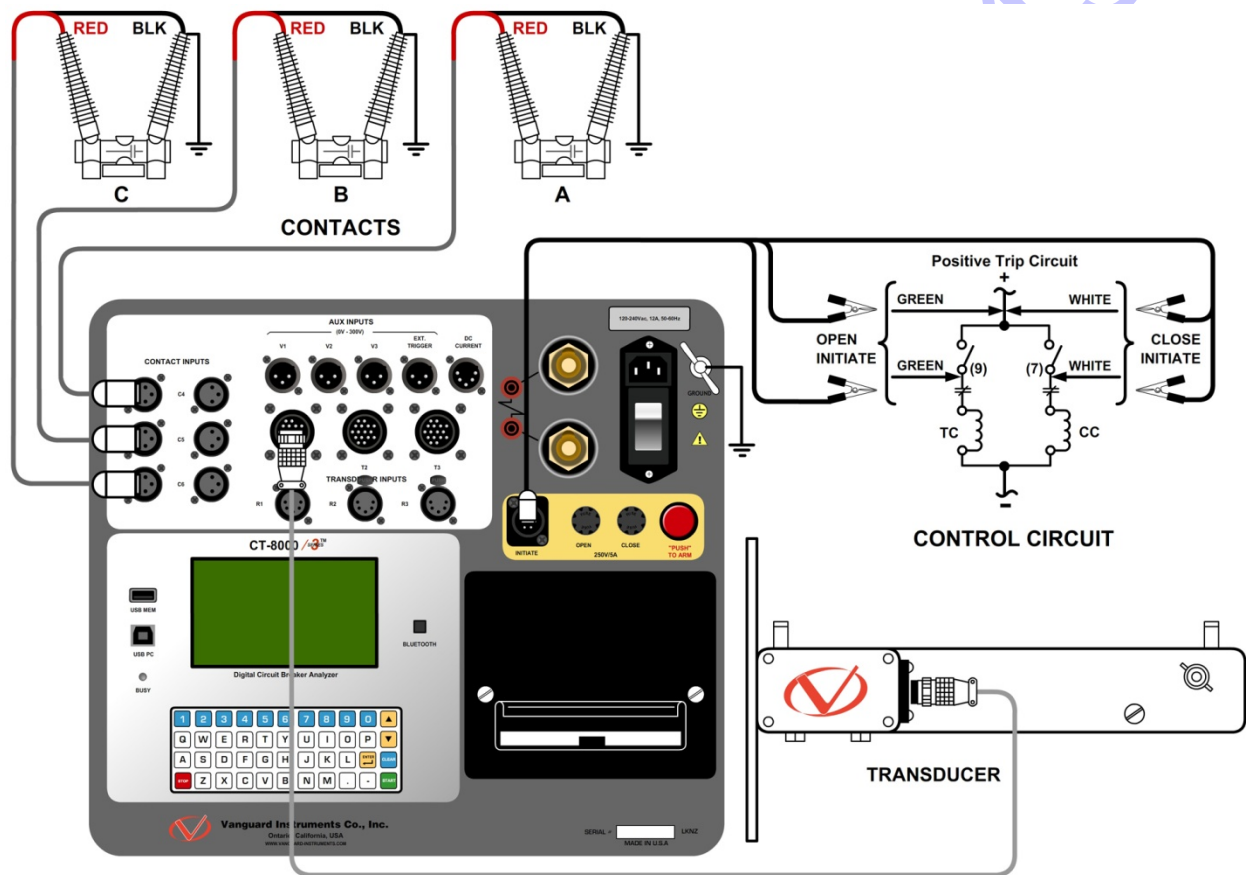

Figure 2. Typical 3-Phase Circuit Breaker Connections

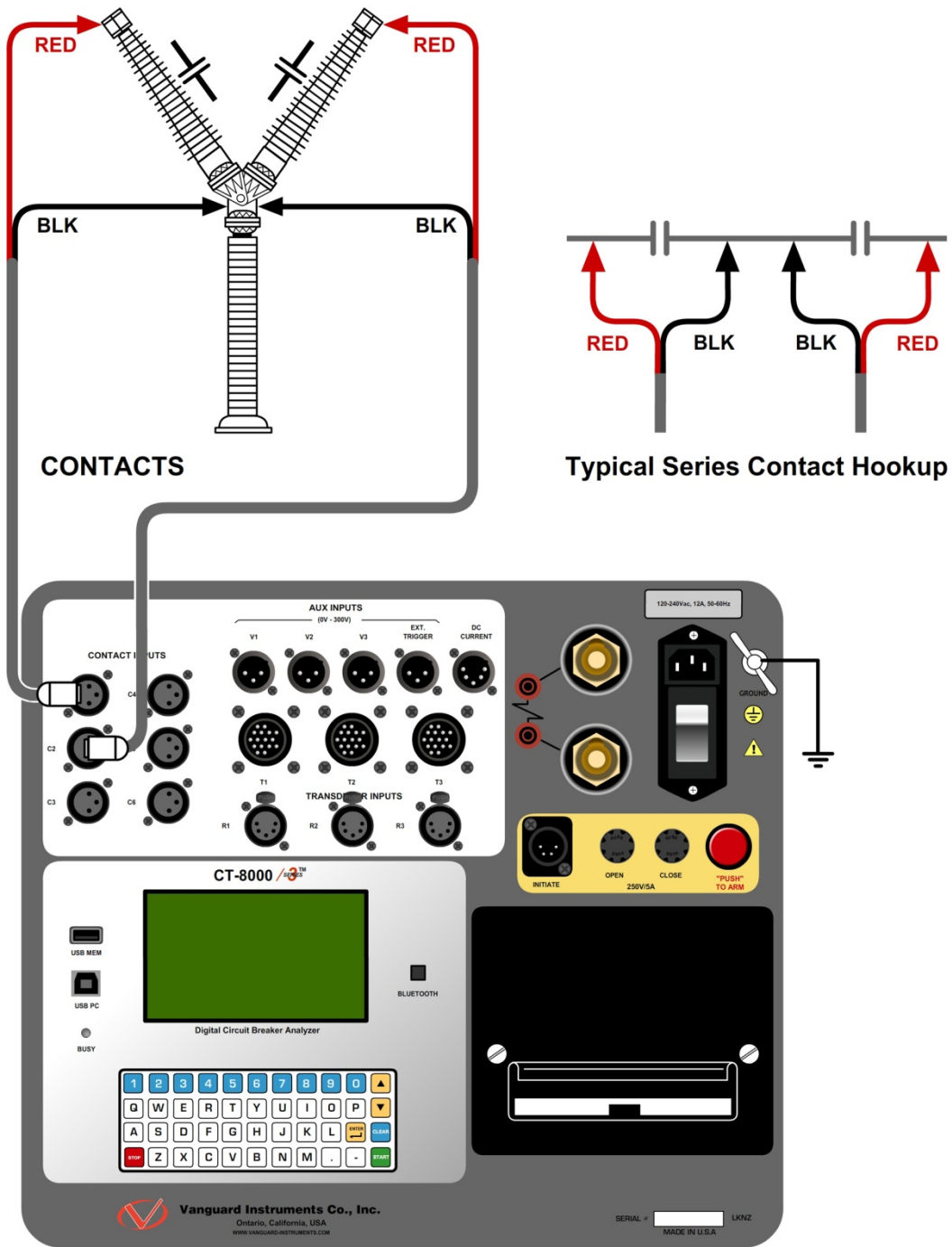

Figure 3. Typical Connections for Series Contact Circuit Breaker

3.1.2. Initiate Cable Connections

The CT-8000 S3 can trip or close breakers through a solid-state device operating on any AC or DC control voltage ranging from 10 to 300 Volts. Both the trip and close circuits are protected by 5 Ampere fuses. A typical DC trip and DC close control circuit connection is shown in Figure 4. A typical DC trip and AC close control circuit connection is shown in Figure 5.

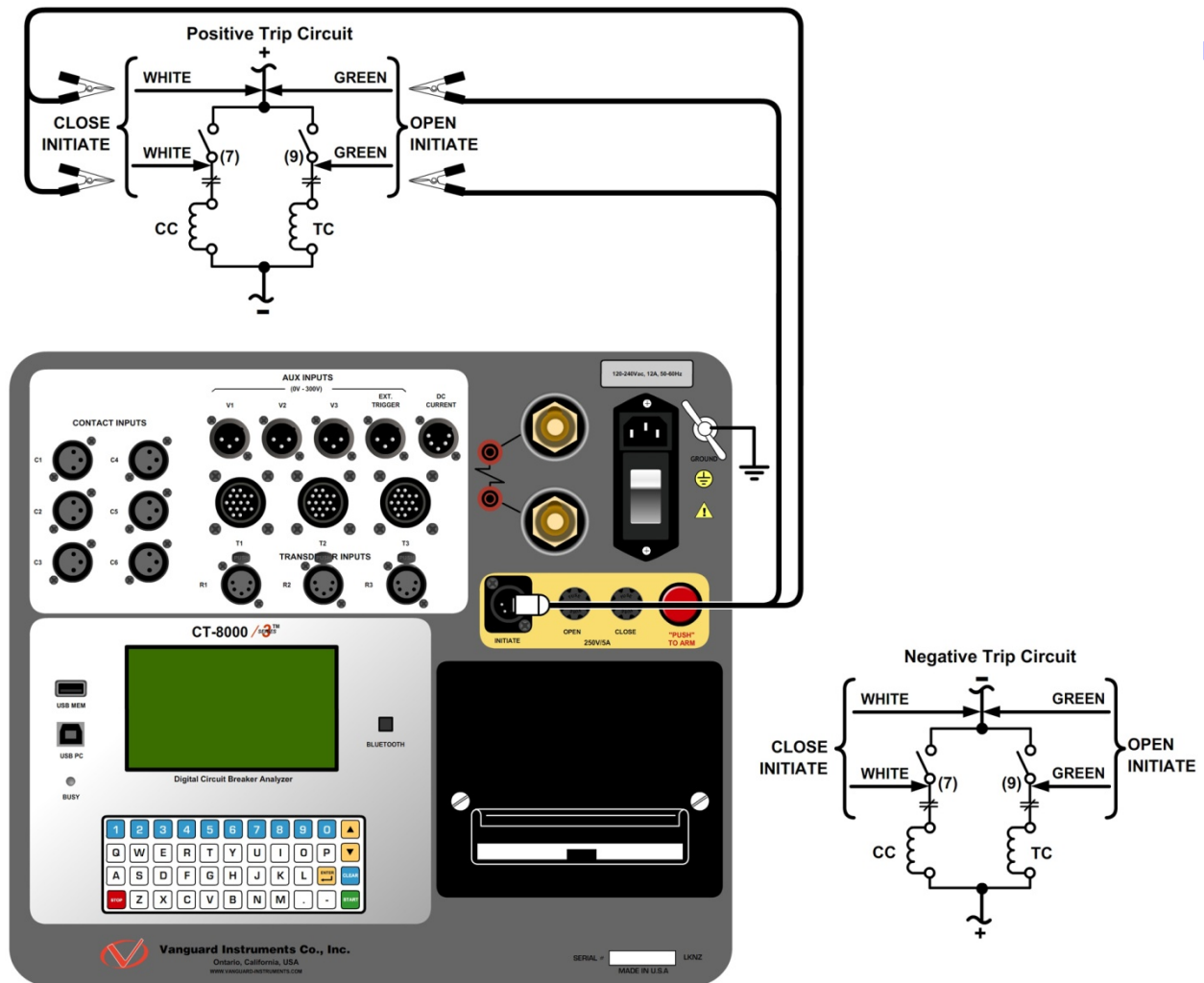

Figure 4. Typical DC Trip and DC Close Control Circuit Connection



NOTE

Auxiliary switches, in series with the OPEN and CLOSE coil control circuit, are used to interrupt the coil current.

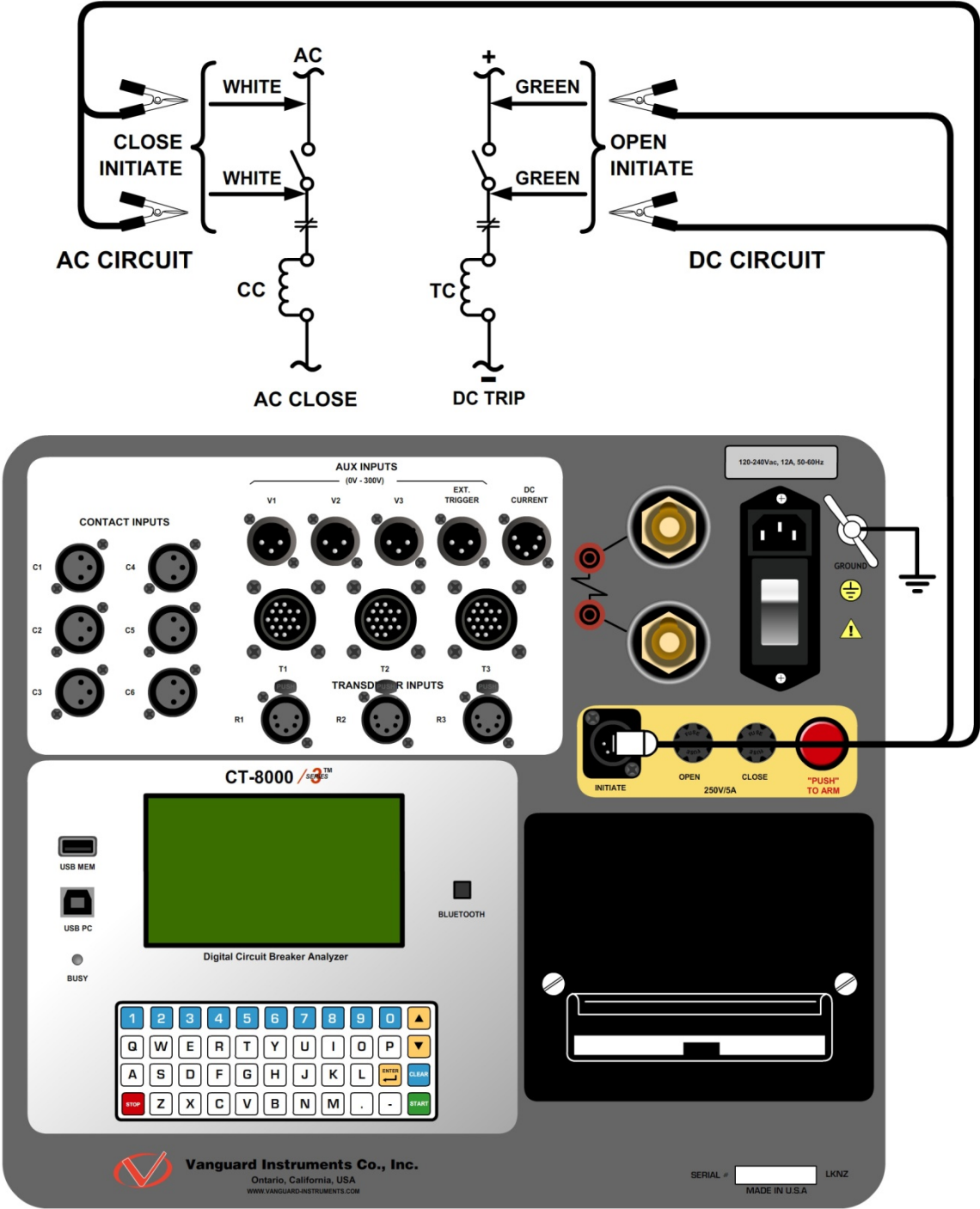



Figure 5. Typical DC Trip and AC Close Control Circuit Connection

3.1.3. Dynamic Resistance Test Connections

A typical connection for performing a dynamic resistance test is shown in Figure 6.

 Do not modify the length of the CT-8000 S3 current cables.

WARNING

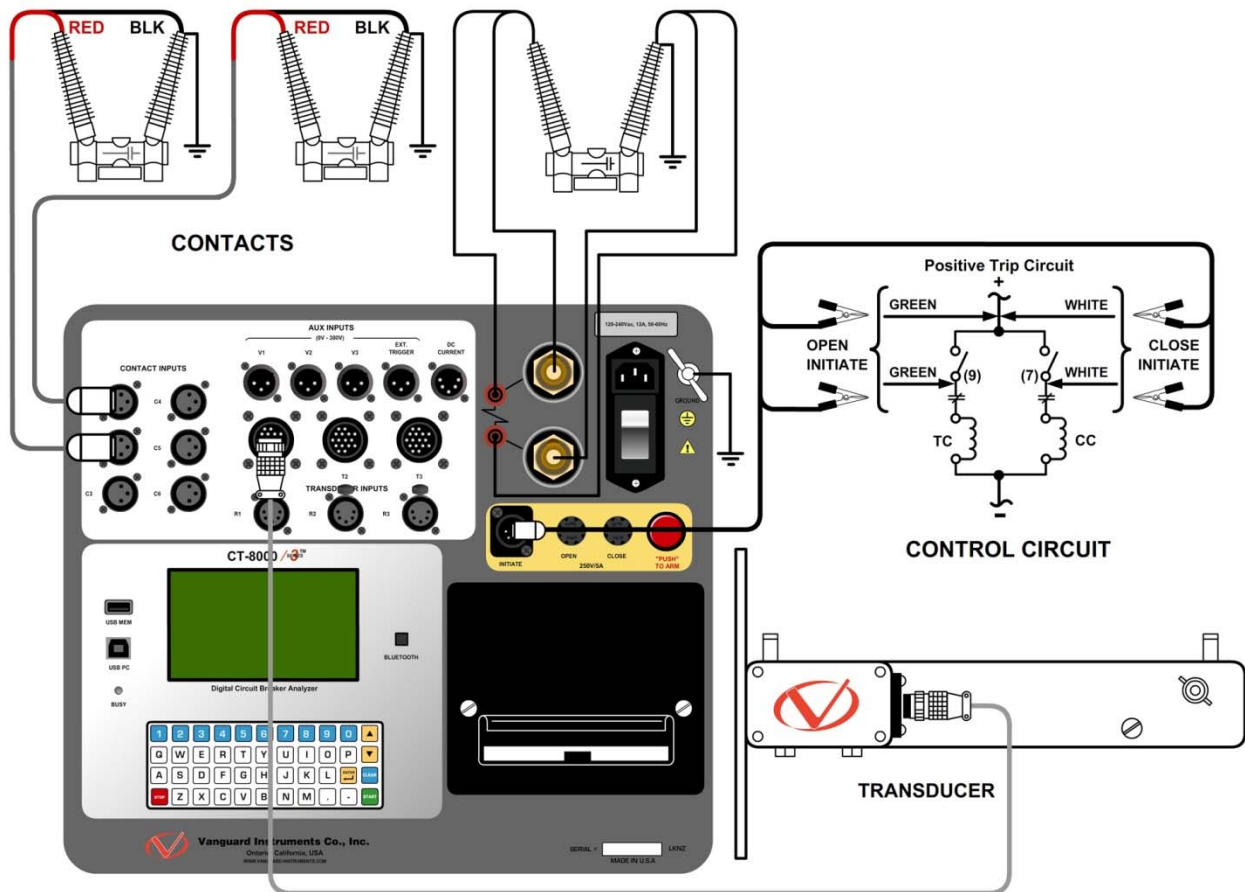

Figure 6. Typical Dynamic Resistance Test Connections

3.1.4. Online Timing Connections (with optional Online Timing feature)

In addition to the conventional off-line timing mode, the CT-8000 S3 also offers an optional three-phase “on-line” timing mode. In this mode, the CT-8000 S3 captures the breaker’s trip or close time, the trip/close coil current “fingerprint”, the battery supply voltage, and auxiliary switch times while the breaker is still in service. The trip/close time is derived from the time of trip, or close coil initiation, to the breaker’s bushing current breaker make/break as detected by a AC clamp-on current sensing probes. Trip/Close current waveforms are also captured by an external clamp-on DC current probe.

The “on-line” timing mode can detect a breaker’s operating conditions with little or no down time. In this mode, the first trip operation time of the breaker is captured. If a breaker has been in service for a long period of time and sitting in close position, the first trip time of the breaker may be slow possibly due to a sticky mechanism. The “on-line” mode is very useful in such cases because traditional breaker timing may not detect this condition since several operations may have occurred before the first timing test is conducted.

The CT-8000 S3 On-Line timing mode requires the use of 3 AC current sensors (provided with the Online Timing Option, Part no. 9103-OT) to monitor the contact time phases A, B, and C. The Open and Close coil current is monitored by using the provided DC current sensor (provided with the Online Timing Option, Part no. 9103-OT). The On-Line timing mode requires the External trigger to be connected. Please see Figure 8 for the On-Line timing test connections.



Figure 7. On-line Timing Probe Set (Part No. 9021-OT)

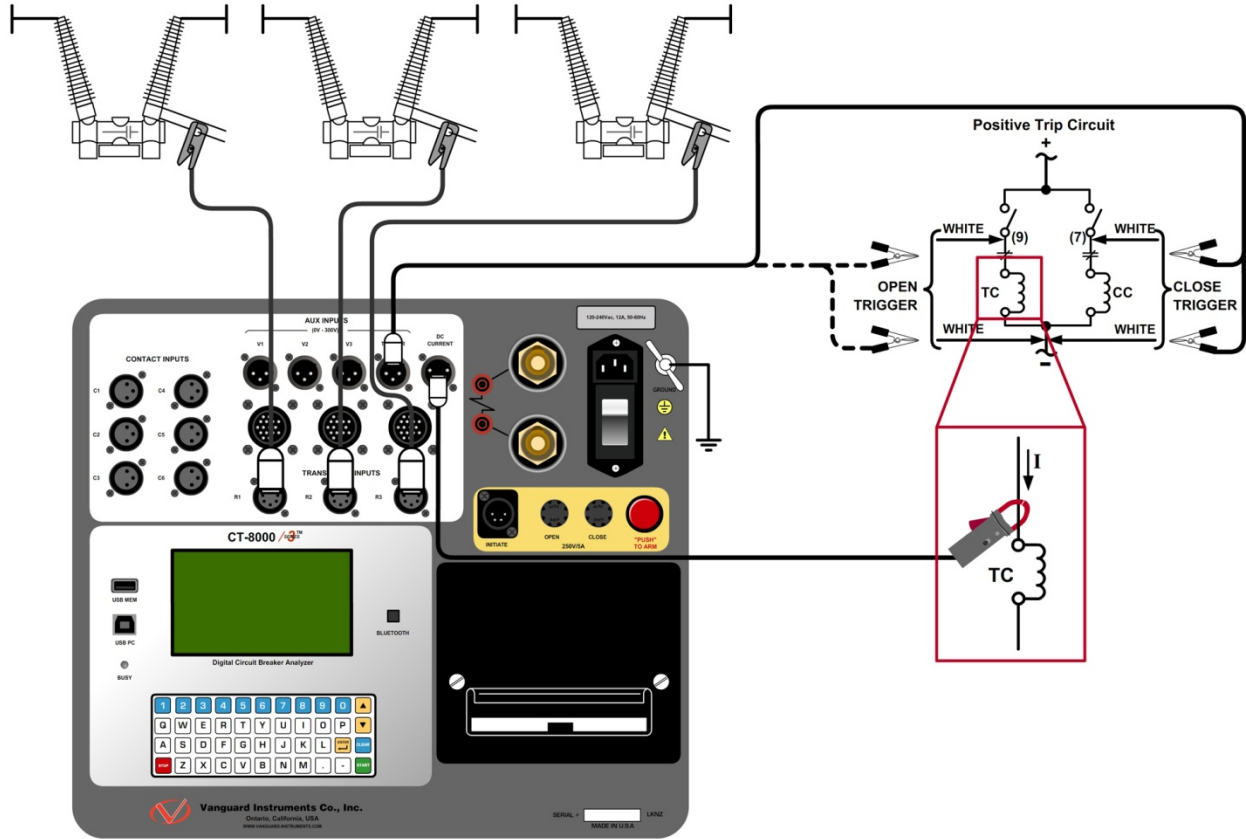

Figure 8. Typical Connections for Optional On-line Timing Mode

3.1.5. Dual Ground Connections (with optional Dual Ground feature)

With the optional dual ground testing mode, the CT-8000 S3 can measure a CB contact time with ground being applied to both sides of the bushings. The clamp-on probe is connected to one side of the CB safety ground straps, and an AC signal is coupled to this strap. A sensor on the probe will detect a change in the induced AC signal when the CB contact is opened or closed.

The CT-8000 S3 Dual Ground test mode requires the use of the Vanguard Dual Ground Current Probes (provided with the Dual Ground option, part no. 9103-DG). Up to 3 timing channels are available with the Dual Ground option. Only timing channels 1, 2, and 3 are used for this mode (see Figure 9).

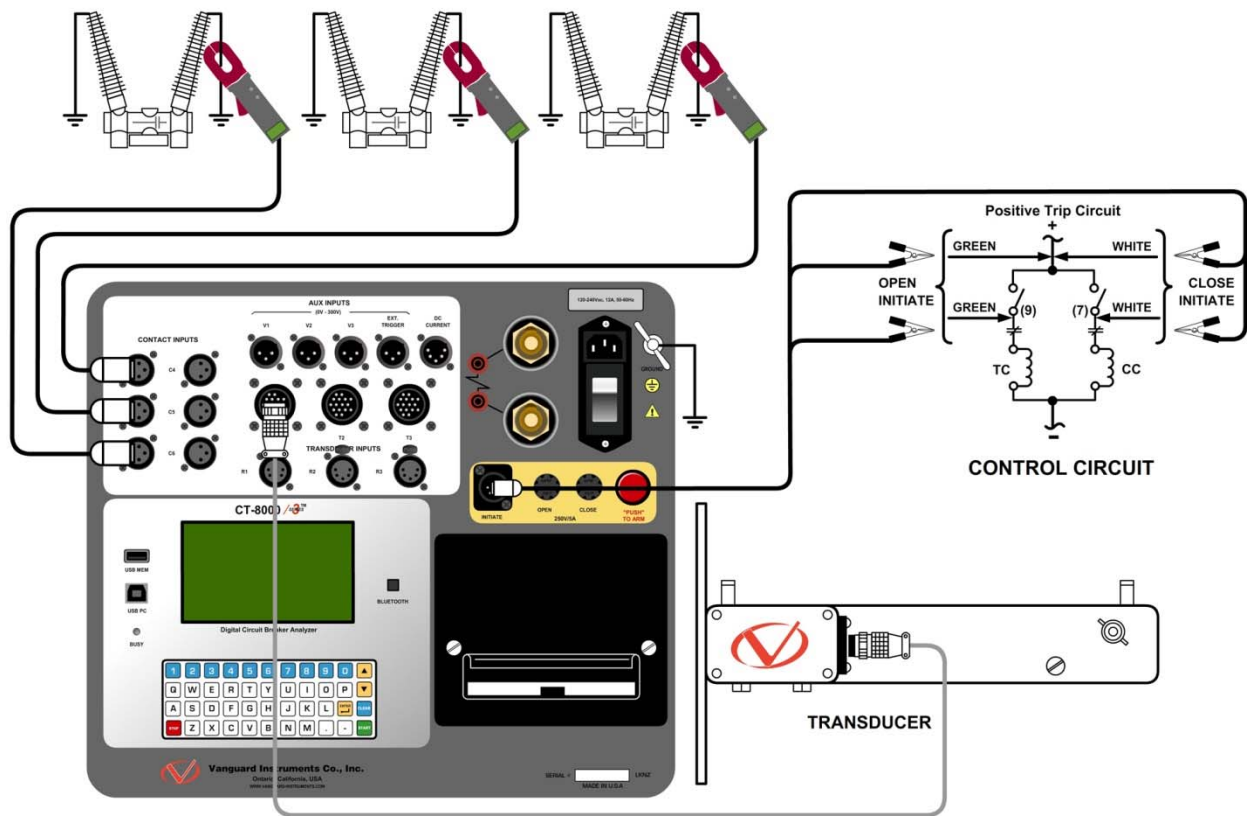

Figure 9. Typical Connections for Optional Dual Ground Testing Mode

NOTE Transducer channels, voltage monitoring channels, and the initiate circuit are connected the same as the regular time travel test mode.

3.1.6. Analog and Digital Voltage Monitoring Connections

The analog voltage input “V1” can monitor a breaker’s DC control voltage during an operation. The analog voltage input records the nominal DC voltage at no load and the minimum DC voltage while the Trip or Close coil is energized. The nominal and minimal voltage readings are printed on a tabulated report, and the analog waveforms are plotted in graphical format. This allows the user to see the breaker’s DC control voltage “dip” under load conditions and helps detect problems such as a poor connection or an excessive voltage drop during operation. Please note that the maximum voltage that can be recorded is 250 Vdc.

The digital voltage input channels “V2” and “V3” can monitor the voltage status as “ON” or “OFF” states. The voltage “ON” or “OFF” states are plotted on the graphical report. Three voltage on/off events are also printed on the tabulated timing report. Typical analog (“V1”) and digital (“V2”) voltage monitoring connections are shown in Figure 10.

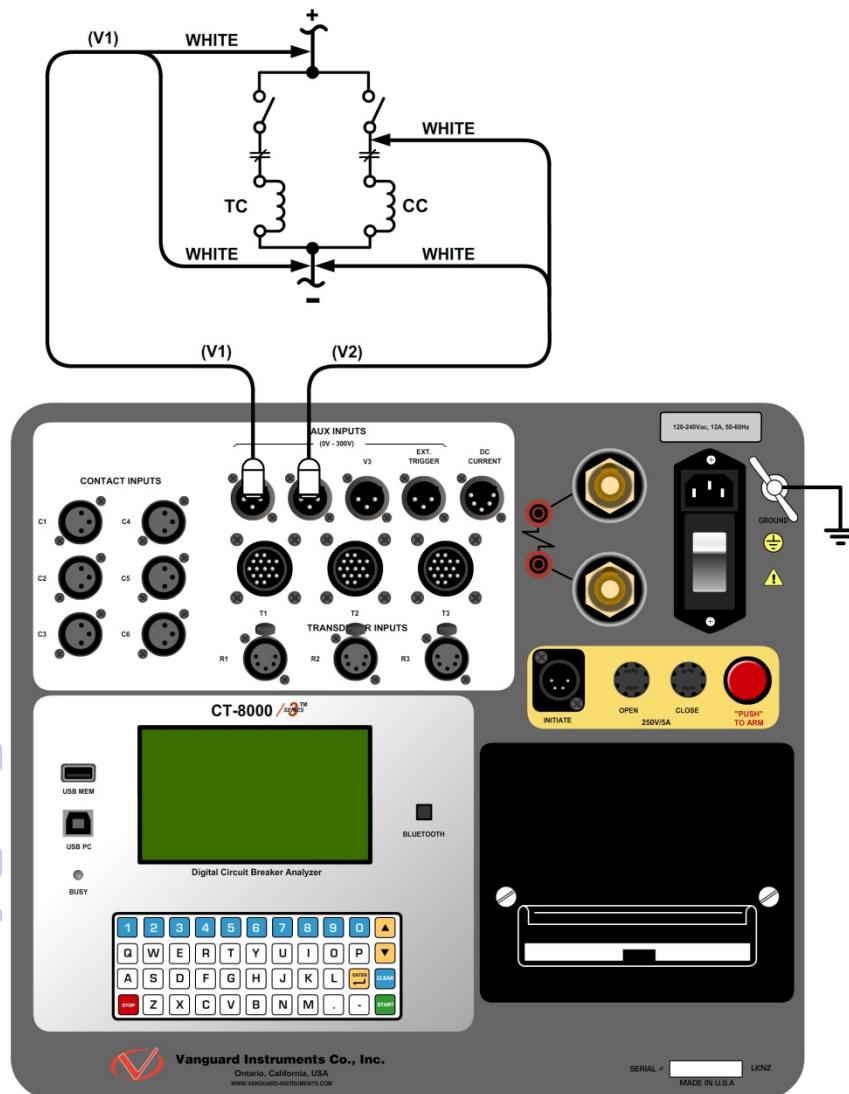

Figure 10. Typical Analog and Digital Voltage Monitoring Connections

3.1.7. External Trigger Input Connections

The External Trigger Mode can be used to start recording data when the CT-8000 S3 senses a voltage. A typical application for the External Trigger Mode is to time a circuit breaker in a Close operation and to start timing only when the Close coil is energized, thus bypassing the 52X relay delay time.

Since the 52X relay carries the Close coil current, the CT-8000 S3's initiate cable must be connected to the Close terminal as shown in Figure 4. The CT-8000 S3 will energize the 52X relay to start the Close operation, which will then start the timing when the CT-8000 S3 senses the voltage across the closing coil. Typical external trigger input connections are shown in Figure 11.

Another application for the External Trigger is to start timing the breaker when the user trips or closes the breaker remotely.



- The minimum trigger voltage is 30 Vac/dc. Maximum, continuous voltage is limited to 300 Vac/dc. Different trigger voltages can be set at the factory by request.
- The CT-8000 S3 will start looking for the external trigger voltage when the message "AWAITING TRIGGER..." is displayed on the LCD screen. The external trigger voltage must be sensed by the CT-8000 S3 within 15 seconds after the initiate sequence has begun. The CT-8000 S3 will return to the "START-UP" menu if no voltage is sensed.

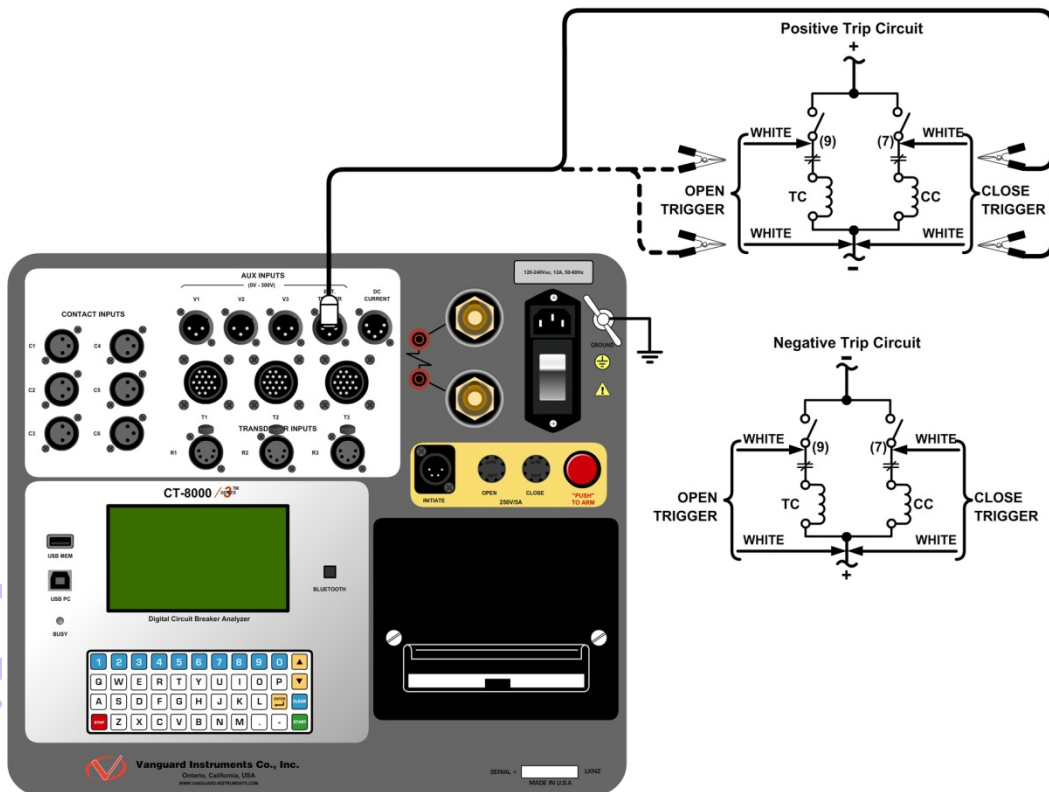

Figure 11. Typical External Trigger Input Cable Connections

3.1.8. Digital Transducer Connection

A typical digital transducer connection is shown in Figure 12.

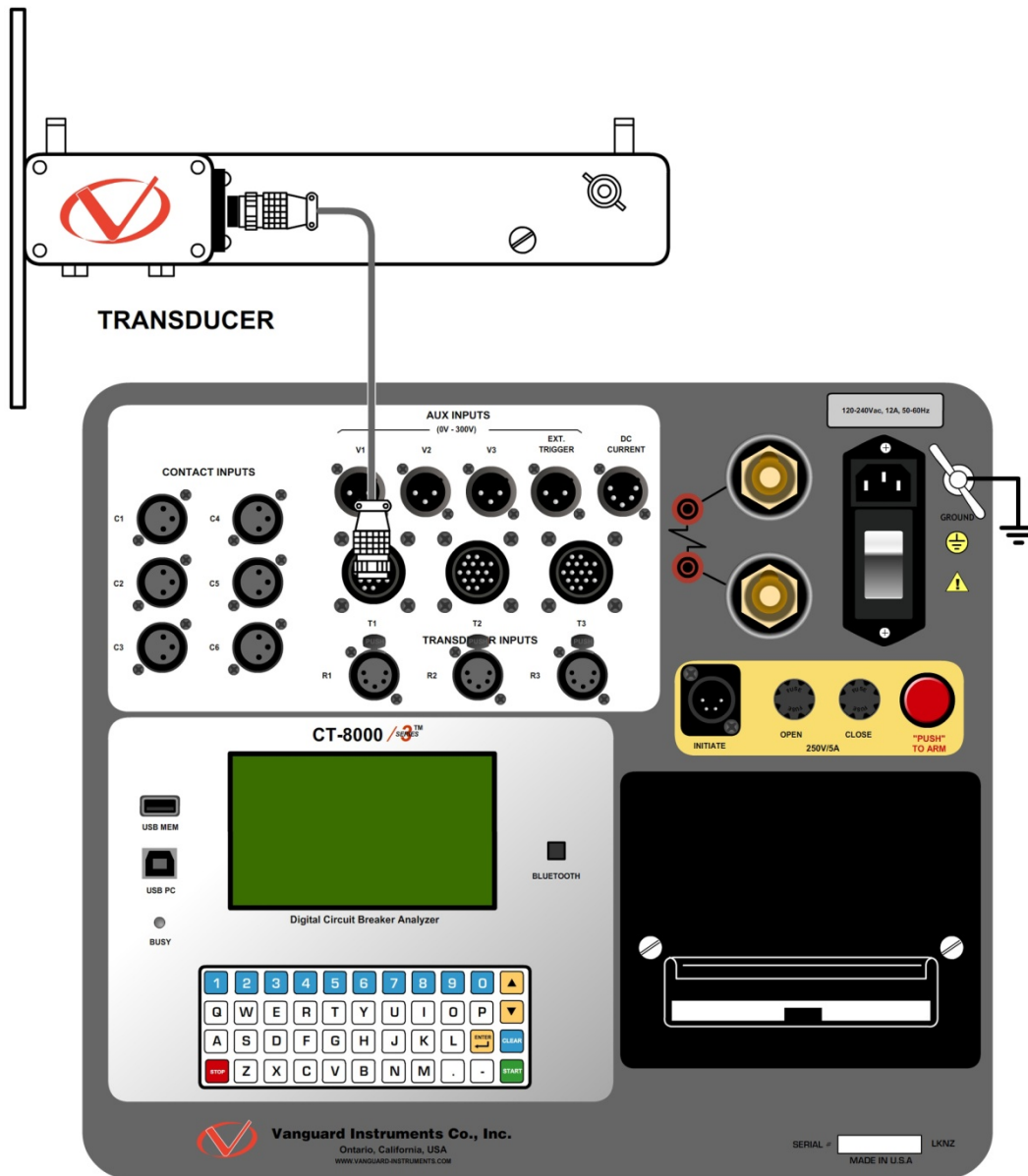

Figure 12. Typical Digital Transducer Connection

3.1.9. Resistor Type Transducer Connection

The CT-8000 S3 provides three input channels for resistor type transducers. The transducer resistance input can range from 200 Ohms to 10K Ohms. The CT-8000 S3 supplies a 5 Vdc reference voltage to power the resistor type transducer. The sense voltage is translated into a travel distance based on the transducer calibration parameters. The user is required to setup the resistor transducer before performing a test. Up to nine transducer setups can be stored in the CT-8000 S3's internal memory. Once a transducer setup is stored, it can be recalled quickly before running a test. A typical resistor type transducer connection is shown in Figure 13.



NOTES

- When a resistor type transducer is selected, all three resistor transducer channels (R1, R2, and R3) are active and will be shown on the test results (see Figure 18).
- A 15-foot transducer cable with 3 quick disconnect clips is provided with each CT-8000 S3. The 3 clips are labeled "+5V", "Signal", and "GND".
- See section 3.2.11 for resistor type transducer calibration information.

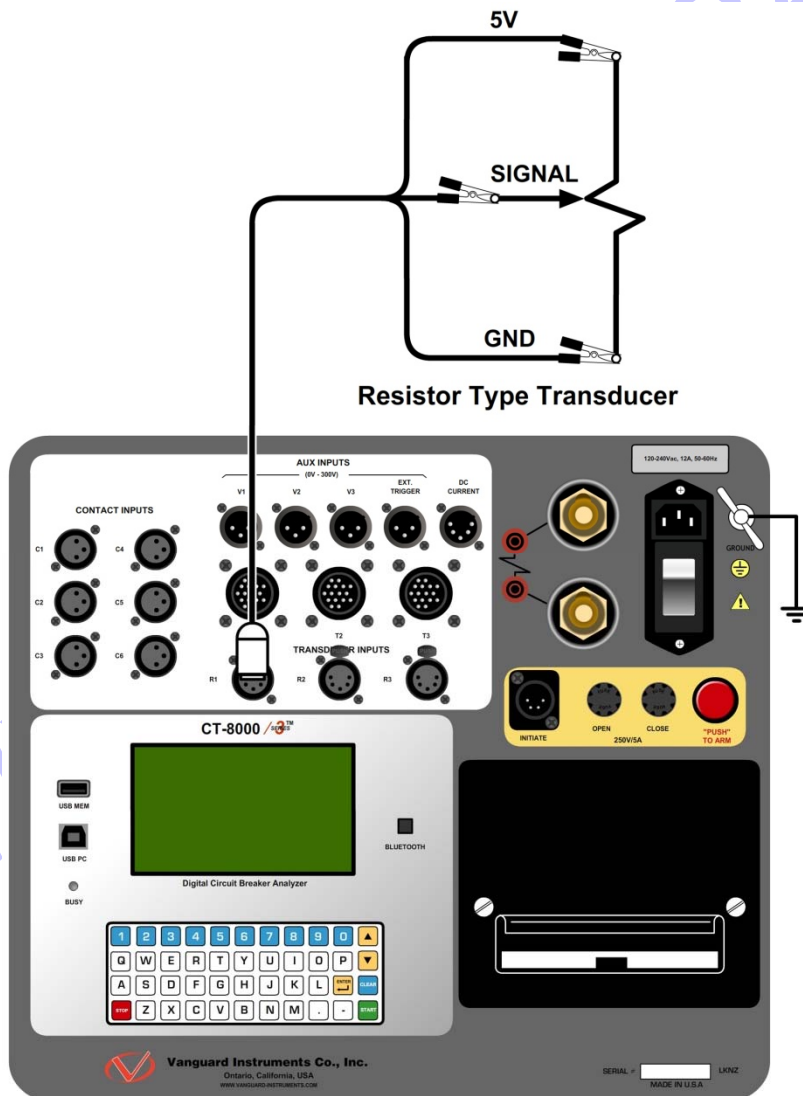

Figure 13. Typical Resistor Type Transducer Connection

3.2 Changing Setup Parameters

3.2.1. Entering Test Record Header Information

You can enter the test record header information before performing tests. The record header includes identifying information such as the company, station, circuit, model number, etc. Once the header information has been entered, it will apply to all subsequent test records. To enter the header information:

- a. When the unit is turned on and the firmware is loaded, you will be presented with the "START-UP" menu as shown below:

```
1. RUN TEST      10/07/13
2. GET RESULTS   10:11:15
3. SAVE/RESTORE
4. SETUP
5. DIAGNOSTICS
```

Press the **[4]** key (*SETUP*).

- b. The following screen will be displayed:

```
1. ANALYSIS POINTS
2. MEASUREMENT UNITS
3. SHOT DESCRIPTION
4. NUMBER OF CHANNELS
5. NEXT PAGE
```

Press the **[3]** key (*SHOT DESCRIPTION*).

- c. The following screen will be displayed:

```
COMPANY:
-
↑↓ TO POSITION
"ENTER" TO ACCEPT
```

Type the company name using the keypad. To erase a character at the cursor position, press the **[CLEAR]** key. Press the **[▲]** key to move to the next character. Press the **[▼]** key to move to the previous character. Press the **[ENTER]** key when you are done typing the company name.

- d. The following screen will be displayed:

```
STATION:  
-  
  
↑↓ TO POSITION  
"ENTER" TO ACCEPT
```

Type the station name using the keypad and then press the **[ENTER]** key.

- e. The following screen will be displayed:

```
CIRCUIT:  
-  
  
↑↓ TO POSITION  
"ENTER" TO ACCEPT
```

Type the circuit information using the keypad and then press the **[ENTER]** key.

- f. The following screen will be displayed:

```
MANUFACTURER:  
-  
  
↑↓ TO POSITION  
"ENTER" TO ACCEPT
```

Type the circuit breaker manufacturer name using the keypad and then press the **[ENTER]** key.

- g. The following screen will be displayed:

```
MODEL:  
-  
  
↑↓ TO POSITION  
"ENTER" TO ACCEPT
```

Type the circuit breaker model information using the keypad and then press the **[ENTER]** key.

- h. The following screen will be displayed:

```
SERIAL NUMBER:  
-  
  
↑↓ TO POSITION  
"ENTER" TO ACCEPT
```

Type the circuit breaker serial number using the keypad and then press the **[ENTER]** key.

- i. The following screen will be displayed:

```
OPERATOR:  
-  
  
↑↓ TO POSITION  
"ENTER" TO ACCEPT
```

Type the operator's name using the keypad and then press the **[ENTER]** key. All header information will be saved, and you will be returned to the "START-UP" menu.

3.2.2. Setting the Clock

Follow the steps below to set the CT-8000 S3's internal clock:

- a. Start from the "START-UP" menu:

```
1. RUN TEST      10/07/13
2. GET RESULTS   10:15:25
3. SAVE/RESTORE
4. SETUP
5. DIAGNOSTICS
```

Press the **[4]** key (*SETUP*).

- b. The following screen will be displayed:

```
1. ANALYSIS POINTS
2. MEASUREMENT UNITS
3. SHOT DESCRIPTION
4. NUMBER OF CHANNELS
5. NEXT PAGE
```

Press the **[5]** key (*NEXT PAGE*).

- c. The following screen will be displayed:

```
1. SET DATE & TIME
2. SET PRINT MODE
3. SET 50/60 HZ
4. SET LANGUAGE
5. BLUETOOTH DEV RESET
6. PREVIOUS PAGE
```

Press the **[1]** key (*SET DATE & TIME*).

- d. The following screen will be displayed:

```
ENTER
MM-DD-YY  HH:MM:SS
-
```

Enter the month, date, time, hours, minutes, and seconds (in 24-hour format) using the alpha-numeric keypad. When the last digit is entered, the clock will be set and you will be returned to the "START-UP" menu.

3.2.3. Configuring Automatic or Manual Printing of Test Results

The CT-8000 S3 can be configured to print graphs and tabulated results automatically or manually after each test. To configure the printing method:

- a. Start from the "START-UP" menu:

```
1. RUN TEST      10/07/13
2. GET RESULTS   10:30:40
3. SAVE/RESTORE
4. SETUP
5. DIAGNOSTICS
```

Press the **[4]** key (*SETUP*).

- b. The following screen will be displayed:

```
1. ANALYSIS POINTS
2. MEASUREMENT UNITS
3. SHOT DESCRIPTION
4. NUMBER OF CHANNELS
5. NEXT PAGE
```

Press the **[5]** key (*NEXT PAGE*).

- c. The following screen will be displayed:

```
1. SET DATE & TIME
2. SET PRINT MODE
3. SET 50/60 HZ
4. SET LANGUAGE
5. BLUETOOTH DEV RESET
6. PREVIOUS PAGE
```

Press the **[2]** key (*SET PRINT MODE*).

- d. The following screen will be displayed:

```
SET PRINT MODE:

1. AUTOMATIC PRINT
2. BY REQUEST ONLY
```

Press the **[1]** key (*AUTOMATIC PRINT*) to automatically print test results after each test.

Press the **[2]** key (*BY REQUEST ONLY*) to manually print test results after each test.

Please see section 3.3.5 for instructions on how to manually print test results.

3.2.4. Setting the Units of Measure

The CT-8000 S3 supports and displays both English and Metric calculations. You can switch between the English and Metric systems using the steps below:

- a. Start from the "START-UP" menu:

```

1. RUN TEST      10/07/13
2. GET RESULTS   10:45:55
3. SAVE/RESTORE
4. SETUP
5. DIAGNOSTICS
  
```

Press the **[4]** key (*SETUP*).

- b. The following screen will be displayed:

```

1. ANALYSIS POINTS
2. MEASUREMENT UNITS
3. SHOT DESCRIPTION
4. NUMBER OF CHANNELS
5. NEXT PAGE
  
```

Press the **[2]** key (*MEASUREMENT UNITS*).

- c. The following screen will be displayed:

```

SELECT UNITS:
1. ENGLISH
2. METRIC
3. ROTARY ENCODER
4. RES ENCODER
  
```

Press the **[1]** key (*ENGLISH*) or the **[2]** key (*METRIC*) to select the corresponding measurement system. The measurement system will be set and you will be returned to the "START-UP" menu.



NOTE

If the measurement system is changed, any relevant values in the working memory will be automatically converted to the new system. Also, if retrieving a test record from the Flash EEPROM, all data will be converted to the new measurement system. There is no need to re-run a test.

3.2.5. Setting the OPEN Timing Analysis Points

Two analysis points are used to calculate the velocity of the circuit breaker in the OPEN operation. To configure the OPEN timing analysis points:

- a. Start from the "START-UP" menu:

```
1. RUN TEST      10/07/13
2. GET RESULTS   11:10:10
3. SAVE/RESTORE
4. SETUP
5. DIAGNOSTICS
```

Press the **[4]** key (*SETUP*).

- b. The following screen will be displayed:

```
1. ANALYSIS POINTS
2. MEASUREMENT UNITS
3. SHOT DESCRIPTION
4. NUMBER OF CHANNELS
5. NEXT PAGE
```

Press the **[1]** key (*ANALYSIS POINTS*).

- c. The following screen will be displayed:

```
1. OPEN TIMING
2. CLOSE TIMING
3. PRINT SETTINGS
4. TEST PLANS
```

Press the **[1]** key (*OPEN TIMING*).

- d. The following screen will be displayed:

```
OPEN ANALYSIS PT 1

1. PERCENT OF STROKE
2. DIST FROM CLOSE
3. CONTACT #1
```

1. *PERCENT OF STROKE*

Press the **[1]** key (*PERCENT OF STROKE*) to set the open analysis point #1 as a percentage of the total stroke value.



Percentage of stroke is the distance based upon the percentage of the total breaker's stroke distance. The distance is always measured from the starting point at the fully closed position of the breaker contacts.

NOTE

The following screen will be displayed:

```

OPEN ANALYSIS PT 1
% OF TOTAL STROKE
00%

"ENTER" TO CONFIRM
  
```

Type the percentage value using the keypad and then press the **[ENTER]** key.

Continue to step e.

2. *DIST FROM CLOSE*

Press the **[2]** key (*DIST FROM CLOSE*) to set the open analysis point #1 as a distance from the contact's close position.



The distance from close range is selectable from 00.0 inch to 99.99 inches or from 0.0 to 999.0 millimeters. The distance is referenced from the contact's closed position.

NOTE

The following screen will be displayed:

```

OPEN ANALYSIS PT 1
VALUE: 000.0 IN
DISTANCE FROM CLOSE

"ENTER" TO CONFIRM
  
```

Type the distance value using the keypad and then press the **[ENTER]** key.

Continue to step e.

3. *CONTACT #1*

Press the **[3]** key (*CONTACT #1*) to set the open analysis point #1 value equal to the contact point #1 value. **Continue to step e.**



Contact point #1 is the distance from the contact's closed position to the point where it is in transition from the CLOSE to OPEN or the OPEN to CLOSE position.

NOTE

- e. The following screen will be displayed:

```

OPEN ANALYSIS PT 2
1. PERCENT OF STROKE
2. DIST FROM CLOSE
3. CONTACT +/- TIME
  
```

1. *PERCENT OF STROKE*

Press the **[1]** key (*PERCENT OF STROKE*) to set the open analysis point #2 as a percentage of the total stroke value. The following screen will be displayed:

```

OPEN ANALYSIS PT 2
% OF TOTAL STROKE
    00%

"ENTER" TO CONFIRM
  
```

Type the percentage value using the numeric keypad and then press the **[ENTER]** key. The analysis points will be set and you will be returned to the "START-UP" menu.

2. *DIST FROM CLOSE*

Press the **[2]** key (*DIST FROM CLOSE*) to set the open analysis point #2 as a distance from the contact's close position. The following screen will be displayed:

```

OPEN ANALYSIS PT 2
VALUE: 000.0 IN
DISTANCE FROM CLOSE

"ENTER" TO CONFIRM
  
```

Type the distance value using the numeric keypad and then press the **[ENTER]** key. The analysis points will be set and you will be returned to the "START-UP" menu.

3. *CONTACT +/- TIME*

Press the **[3]** key to select the *CONTACT +/- TIME* option. The following screen will be displayed:

```

OPEN ANALYSIS PT 2
1. CONTACT PLUS TIME
2. CONTACT MINUS TIME
  
```

1. CONTACT PLUS TIME

Press the **[1]** key to select the *CONTACT PLUS TIME* option.



NOTE

For the contact plus time, the user enters the time (in milliseconds) after the contact channel #1 made the transition from OPEN to CLOSE or CLOSE to OPEN to define the analysis point #2.

The following screen will be displayed:

```

OPEN ANALYSIS PT 2
ENTER TIME FROM CH1
TIME (MS): 000

"ENTER" TO CONFIRM
  
```

Type the time value using the numeric keypad and then press the **[ENTER]** key. The analysis points will be set and you will be returned to the "START-UP" menu.

2. CONTACT MINUS TIME

Press the **[2]** key to select the *CONTACT MINUS TIME* option.



NOTE

For the contact minus time, the user enters the time (in milliseconds) before the contact channel #1 makes the transition from OPEN to CLOSE or CLOSE to OPEN to define the analysis point #2.

The following screen will be displayed:

```

OPEN ANALYSIS PT 2
ENTER TIME FROM CH1
TIME (MS): 000

"ENTER" TO CONFIRM
  
```

Type the time value using the numeric keypad and then press the **[ENTER]** key. The analysis points will be set and you will be returned to the "START-UP" menu.



NOTES

- Average velocity through the arc zone is calculated using the following formula:
 $V_{avg} = \text{Distance} / \text{Time}$
- The breaker contact velocity can be recalculated based on the data stored in the memory after any new analysis points are selected. The user does NOT need to operate the breaker again to acquire new contact velocity data after changing the analysis points because the new velocity will be calculated from the travel data stored in the memory from the last operation.
- For complex velocity calculations, the user can create a test plan using the included CT-8000 S3 Breaker Analysis PC Software. The test plan can then be downloaded to the CT-8000 S3 and recalled before running timing tests.

3.2.6. Selecting the Contact Cycle Reading Frequency

The contact time is printed on the tabulated test results printout in both milliseconds and cycles. The cycle readings can be in 50 Hz or 60 Hz. You can select the preferred frequency using the steps below:

- a. Start from the "START-UP" menu:

```
1. RUN TEST      10/07/13
2. GET RESULTS   11:13:17
3. SAVE/RESTORE
4. SETUP
5. DIAGNOSTICS
```

Press the **[4]** key (*SETUP*).

- b. The following screen will be displayed:

```
1. ANALYSIS POINTS
2. MEASUREMENT UNITS
3. SHOT DESCRIPTION
4. NUMBER OF CHANNELS
5. NEXT PAGE
```

Press the **[5]** key (*NEXT PAGE*).

- c. The following screen will be displayed:

```
1. SET DATE & TIME
2. SET PRINT MODE
3. SET 50/60 HZ
4. SET LANGUAGE
5. BLUETOOTH DEV RESET
6. PREVIOUS PAGE
```

Press the **[3]** key (*SET 50/60 HZ*).

- d. The following screen will be displayed:

```
1. SET 50 HZ
2. SET 60 HZ
```

Press either the **[1]** key (*SET 50 Hz*) or the **[2]** key (*SET 60 Hz*) to set the frequency to the corresponding value.

- e. The following confirmation screen will be displayed:

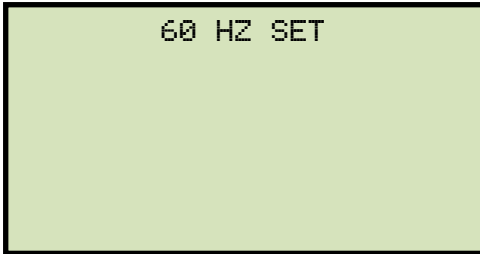

Press any key to return to the “START-UP” menu. Sample tabulated test results are shown in Figure 14 and Figure 15.



If the frequency value is changed, the cycle values are automatically re-calculated by the CT-8000 S3.

NOTE

BREAKER TIMING RESULTS - 50 Hz				
SHOT NUMBER: 10 DATE: 09/30/13 TIME: 08:00:26				
COMPANY: UIC STATION: LAB CIRCUIT: MFR: MODEL: CT 7000 S2 S/N: 130017 OPERATOR: LU				
TEST: OPEN				
CH	TIME <ms>	CYCLE	BOUNCE <ms>	WIPE <mm>
1	99.90	1.66	0.08	99.20
2	99.95	1.69	0.08	99.20
3	99.25	1.66	0.15	98.4
DELTA TIME <ms>: 0.70				
TRAVEL ANALYSIS T1 STROKE mm 119.5 SPEED M/S 4.04 QUER-TRAVEL mm 0.8 BOUNCE BACK mm 0.2				
SPEED ANALYSIS: POINT 1 = 10% POINT 2 = 50%				
U1 NOMINAL VOLTAGE = 0 VOLTS U1 MINIMUM VOLTAGE = 0 VOLTS				
U2/U3 TRANSITION TIMES				
	U2		U3	
T1:	95.20 ms		N/A	
T2:	N/A		N/A	
T3:	N/A		N/A	
INITIATOR CURRENT = 11.0 AMPS				
SHOT LENGTH: 1 SECOND INSERTION RESISTOR: NO TRIGGER: INTERNAL				

Frequency Set to 50 Hz

Cycle readings at 50 Hz

Figure 14. Typical 50 Hz Tabulated Test Results

BREAKER TIMING RESULTS - 60 Hz				
SHOT NUMBER: 10 DATE: 09/30/13 TIME: 08:00:26				
COMPANY: UIC STATION: LAB CIRCUIT: MFR: MODEL: CT 7000 S2 S/N: 130017 OPERATOR: LU				
TEST: OPEN				
CH	TIME <ms>	CYCLE	BOUNCE <ms>	WIPE <mm>
1	99.90	2.00	0.08	99.20
2	99.95	2.04	0.08	99.20
3	99.25	1.99	0.15	98.4
DELTA TIME <ms>: 0.70				
TRAVEL ANALYSIS T1 STROKE mm 119.5 SPEED M/S 4.04 QUER-TRAVEL mm 0.8 BOUNCE BACK mm 0.2				
SPEED ANALYSIS: POINT 1 = 10% POINT 2 = 50%				
U1 NOMINAL VOLTAGE = 0 VOLTS U1 MINIMUM VOLTAGE = 0 VOLTS				
U2/U3 TRANSITION TIMES				
	U2		U3	
T1:	95.20 ms		N/A	
T2:	N/A		N/A	
T3:	N/A		N/A	
INITIATOR CURRENT = 11.0 AMPS				
SHOT LENGTH: 1 SECOND INSERTION RESISTOR: NO TRIGGER: INTERNAL				

Frequency set to 60 Hz

Cycle readings at 60 Hz

Figure 15. Typical 60 Hz Tabulated Test Results

3.2.7. Configuring the Channel Settings

The CT-8000 S3 is available with 3 or 6 contact inputs. Since most common timing applications require the use of only 3 contact timing channels and one travel transducer channel, there is no need to print data for more than 3 timing channels and one transducer channel on the graphic and tabulated reports. The CT-8000 S3 is configured to print 3 contact channels by default (channels 1, 2, and 3) and one transducer channel (transducer channel #1). The default settings can be changed using the steps below:



The CT-8000 S3 will always acquire data for all channels and store it in the working memory when a test is performed.

NOTE

- a. Start from the "START-UP" menu:

```
1. RUN TEST      10/07/13
2. GET RESULTS  11:21:18
3. SAVE/RESTORE
4. SETUP
5. DIAGNOSTICS
```

Press the **[4]** key (*SETUP*).

- b. The following screen will be displayed:

```
1. ANALYSIS POINTS
2. MEASUREMENT UNITS
3. SHOT DESCRIPTION
4. NUMBER OF CHANNELS
5. NEXT PAGE
```

Press the **[4]** key (*NUMBER OF CHANNELS*).

- c. The following screen will be displayed:

```
NUMBER OF CHANNELS
1. 3 CONTACTS
2. 6 CONTACTS
```



NOTE

The number of channels listed on this screen depends on the CT-8000 S3 model. For example, if your unit has only 3 channels (Model CT-8000 S3-3), only option 1 (3 Contacts) will be available.

Press either the **[1]** key (3 CONTACTS) or the **[2]** key (6 CONTACTS) to select the corresponding number of contact channels.

- d. The following screen will be displayed:

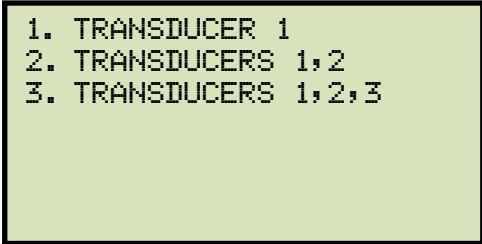

```
1. TRANSDUCER 1
2. TRANSDUCERS 1,2
3. TRANSDUCERS 1,2,3
```

Select the number of transducer channels by pressing either the **[1]**, **[2]**, or **[3]** key. The configuration information will be saved and you will be returned to the "START-UP" menu.

3.2.8. Configuring the Contact Filter Settings

Although the CT-8000 S3 automatically detects the contact time using its own algorithm, it also allows the user to enter a custom filter value. The value can be between 1 and 300. A filter setting of 1 allows the CT-8000 S3 to pick up the first contact transition time after the resistor contact activity is detected. A filter setting of 300 allows the CT-8000 S3 to pick up the last contact transition time after the resistor contact activity is detected. Use the steps below to set the contact filter value:

- a. Start from the "START-UP" menu:

```
1. RUN TEST      10/08/13
2. GET RESULTS  10:10:10
3. SAVE/RESTORE
4. SETUP
5. DIAGNOSTICS
```

Press the **[5]** key (*DIAGNOSTICS*).

- b. The following screen will be displayed:

```
1. SLOW CLOSE TEST
2. CHECK HOOKUP
3. TEST TRANSDUCER
4. PRINT DATA
5. ENCODER FILTER
6. CONTACT FILTER
```

Press the **[6]** key (*CONTACT FILTER*).

- c. The following screen will be displayed:

```
ENTER FILTER SETTING
      (1 - 300)
CURRENT SETTING: 1
NEW SETTING?
```

Type the new filter value using the numeric keypad and then press the **[ENTER]** key. The contact filter value will be set and you will be returned to the "START-UP" menu.



NOTE

The filter value will be reset to the automatic setting when the unit's power is cycled.

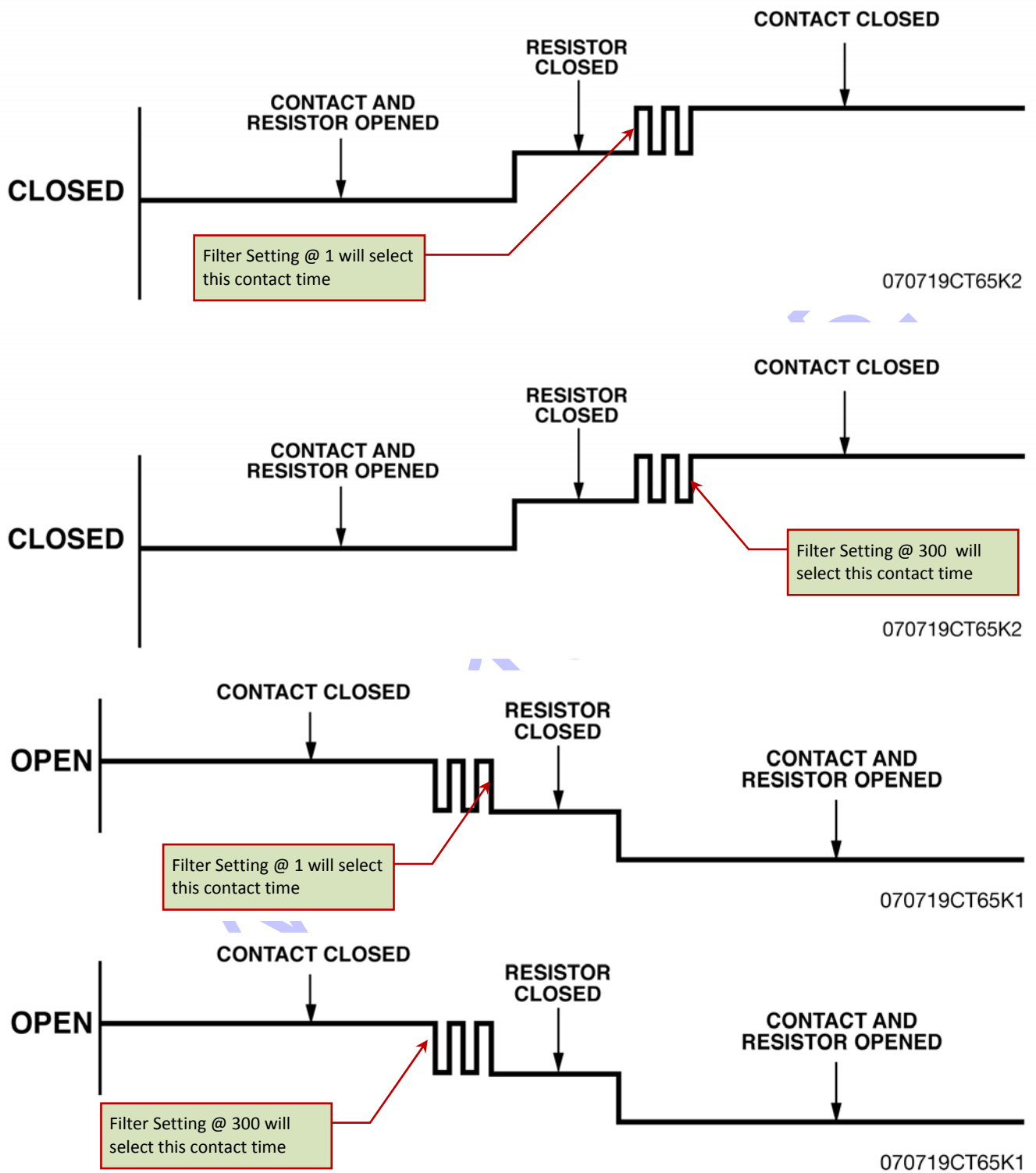

Figure 16. Contact Filter Setting Illustrations

3.2.9. Configuring the Transducer Encoder Filter Setting

In a typical 1-second timing record, the CT-8000 S3 records 20,000 data points for each of the contact channels, digital transducer channels, voltage input channels, CT channel, DCR channel, resistor transducer channel, and initiate current channel. In most circuit breaker timing applications, the breaker activities end after 200 milliseconds. A common problem found in the field is that after the breaker activities have ended, the CT-8000 S3 may record erroneous data on the transducer channels due to vibration. The erroneous data may be due to the transducer not being secured properly to the mounting plate or due to a poor linkage problem between the transducer and the circuit breaker mechanism.

To address this problem, the CT-8000 S3's transducer encoder filter setting can be used to stop recording the transducer channel data after a specific time. This feature can filter out the unwanted motion picked up by the transducer after the breaker activities have ended. The CT-8000 S3's default filter value is set to "No Filter" when the unit is powered on. Use the steps below to change the transducer encoder filter setting:

- a. Start from the "START-UP" menu:

```
1. RUN TEST      10/08/13
2. GET RESULTS   10:10:10
3. SAVE/RESTORE
4. SETUP
5. DIAGNOSTICS
```

Press the **[5]** key (*DIAGNOSTICS*).

- b. The following screen will be displayed:

```
1. SLOW CLOSE TEST
2. CHECK HOOKUP
3. TEST TRANSDUCER
4. PRINT DATA
5. ENCODER FILTER
6. CONTACT FILTER
```

Press the **[5]** key (*ENCODER FILTER*).

- c. The following screen will be displayed:



Type the filter time (in milliseconds) using the keypad, and then press the **[ENTER]** key to return to the "START-UP" menu. The CT-8000 S3 will not record any transducer encoder data after this time.

3.2.10. Configuring the Digital Rotary Transducer Settings

A rotary transducer requires the user to enter the defined linear distance in millimeters or inches per one degree of rotary motion. Follow the steps below to configure the settings for a digital rotary transducer:

- a. Start from the "START-UP" menu:

```
1. RUN TEST      10/08/13
2. GET RESULTS   10:10:10
3. SAVE/RESTORE
4. SETUP
5. DIAGNOSTICS
```

Press the **[4]** key (*SETUP*).

- b. The following screen will be displayed:

```
1. ANALYSIS POINTS
2. MEASUREMENT UNITS
3. SHOT DESCRIPTION
4. NUMBER OF CHANNELS
5. NEXT PAGE
```

Press the **[2]** key (*MEASUREMENT UNITS*).

- c. The following screen will be displayed:

```
SELECT UNITS:
1. ENGLISH
2. METRIC
3. ROTARY ENCODER
4. RES ENCODER
```

Press the **[3]** key (*ROTARY ENCODER*).

- d. The following screen will be displayed:

```
ROTARY ENCODER:
1. ENGLISH (IN./DEG)
2. METRIC (MM/DEG)
```

1. *ENGLISH (In./deg)*

Press the **[1]** key to enter the rotary encoder linear distance per degree using English units (inches per degree). The following screen will be displayed:

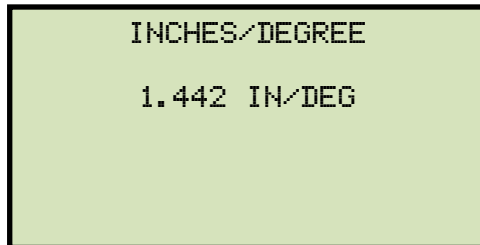

```
INCHES/DEGREE
1.442 IN/DEG
```

Type the desired value using the keypad. You can press the **[CLEAR]** key to reset the value to 0.000 In/Deg. Press the **[ENTER]** key to save the new value. You will be returned to the "START-UP" menu.

2. *METRIC (MM/deg)*

Press the **[2]** key to enter the rotary encoder linear distance per degree using Metric units (millimeters per degree). The following screen will be displayed:

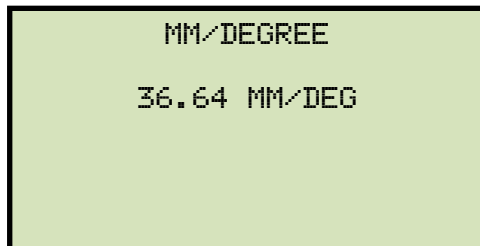

```
MM/DEGREE
36.64 MM/DEG
```

Type the desired value using the keypad. You can press the **[CLEAR]** key to reset the value to 0.000 MM/Deg. Press the **[ENTER]** key to save the new value. You will be returned to the "START-UP" menu.

3.2.11. Configuring the Resistor Type Transducer Settings

The CT-8000 S3 provides three resistor type transducer channels. The transducer must be configured before it can be used with the CT-8000 S3. Up to 9 resistor transducer setups can be stored in the CT-8000 S3's Flash EEPROM. When a resistive transducer is used with the CT-8000 S3, it is shown as transducer #1 on the timing report as shown in Figure 18.

Creating a New Resistor Type Transducer Setup

Follow the steps below to create a new resistor type transducer setup:

- a. Start from the "START-UP" menu:

```
1. RUN TEST      10/08/13
2. GET RESULTS   10:10:10
3. SAVE/RESTORE
4. SETUP
5. DIAGNOSTICS
```

Press the **[4]** key (*SETUP*).

- b. The following screen will be displayed:

```
1. ANALYSIS POINTS
2. MEASUREMENT UNITS
3. SHOT DESCRIPTION
4. NUMBER OF CHANNELS
5. NEXT PAGE
```

Press the **[2]** key (*MEASUREMENT UNITS*).

- c. The following screen will be displayed:

```
SELECT UNITS:
1. ENGLISH
2. METRIC
3. ROTARY ENCODER
4. RES ENCODER
```

Press the **[4]** key (*RES ENCODER*).

- d. The following screen will be displayed:

```
RESISTIVE ENCODER:  
1. CREATE NEW SETUP  
2. LOAD SETUP  
3. PRINT SETUP DIR
```

Press the **[1]** key (*CREATE NEW SETUP*).

- e. The following screen will be displayed:

```
RESISTIVE ENCODER:  
1. ENGLISH (IN./DEG)  
2. METRIC (MM/DEG)
```

Press the **[1]** key to enter the transducer travel distance per volt using English units (in inches per degree), or press the **[2]** key to enter the transducer travel distance per volt using Metric units (in millimeters per degree).

- f. The following screen will be displayed:

```
MOVE RES ENCODER TO  
REFERENCE POSITION  
  
"ENTER TO CONTINUE"
```

Move the transducer to the reference position and press the **[ENTER]** key.

- g. The following screen will be displayed:

```
MOVE RES ENCODER TO  
KNOWN DISTANCE  
  
"ENTER TO CONTINUE"
```

Move the transducer a known distance and press the **[ENTER]** key.

- h. The following screen will be displayed (the units of measure displayed will depend on your choice in step e):

```
ENTER THE DISTANCE
      MOVED:
          IN

"ENTER TO CONTINUE"
```

Enter the distance the transducer was moved using the keypad, and then press the **[ENTER]** key.

- i. The following screen will be displayed:

```
ENTER SETUP NOTE:

↑/↓ TO POSITION
"ENTER" TO ACCEPT
```

If you prefer, you can enter a note to be associated with the setup using the keypad. Press the **[ENTER]** key when done typing.

- j. The following screen will be displayed:

```
ENTER SETUP NUMBER
TO SAVE (1-9)
```

Enter a setup number from 1 to 9 using the keypad.

- k. The following screen will be displayed:

```
"ENTER" TO SAVE

SETUP NUMBER 1
```

Press the **[ENTER]** key to save the setup.



If a setup already exists at the selected memory location, it will be over-ridden by the new setup values.

NOTE

- I. The setup will be saved and the following confirmation screen will be displayed:

```
SETUP SAVED!
```

Press any key to return to the "START-UP" menu.

Loading a Resistor Type Transducer Setup

Follow the steps below to load a resistor type transducer setup:

- a. Start from the "START-UP" menu:

```
1. RUN TEST      10/08/13
2. GET RESULTS   10:10:10
3. SAVE/RESTORE
4. SETUP
5. DIAGNOSTICS
```

Press the **[4]** key (*SETUP*).

- b. The following screen will be displayed:

```
1. ANALYSIS POINTS
2. MEASUREMENT UNITS
3. SHOT DESCRIPTION
4. NUMBER OF CHANNELS
5. NEXT PAGE
```

Press the **[2]** key (*MEASUREMENT UNITS*).

- c. The following screen will be displayed:

```
SELECT UNITS:
1. ENGLISH
2. METRIC
3. ROTARY ENCODER
4. RES ENCODER
```

Press the **[4]** key (*RES ENCODER*).

- d. The following screen will be displayed:

```
RESISTIVE ENCODER:
1. CREATE NEW SETUP
2. LOAD SETUP
3. PRINT SETUP DIR
```

Press the **[2]** key (*LOAD SETUP*).

- e. The following screen will be displayed:

```
ENTER SETUP NUMBER
TO LOAD (1-9)
```

Type the setup number to load using the numeric keypad.



If there is no setup stored in the selected memory location, the following screen will be displayed:

NOTE

```
SETUP NOT FOUND!
```

Press any key to return to the "START-UP" menu.

- f. The following screen will be displayed:

```
SETUP NUMBER: 1
NOTE
ENGLISH

"ENTER" TO CONTINUE
```

Press the **[ENTER]** key to load the selected setup.

- g. The following confirmation screen will be displayed:

```
SETUP LOADED!
```

Press any key to return to the "START-UP" menu.

Printing a Resistor Type Transducer Setup Directory

You can print a directory of the stored resistor type transducer setups on the built-in thermal printer using the steps below:

- a. Start from the "START-UP" menu:

```
1. RUN TEST      10/08/13
2. GET RESULTS   10:10:10
3. SAVE/RESTORE
4. SETUP
5. DIAGNOSTICS
```

Press the **[4]** key (*SETUP*).

- b. The following screen will be displayed:

```
1. ANALYSIS POINTS
2. MEASUREMENT UNITS
3. SHOT DESCRIPTION
4. NUMBER OF CHANNELS
5. NEXT PAGE
```

Press the **[2]** key (*MEASUREMENT UNITS*).

- c. The following screen will be displayed:

```
SELECT UNITS:
1. ENGLISH
2. METRIC
3. ROTARY ENCODER
4. RES ENCODER
```

Press the **[4]** key (*RES ENC*).

- d. The following screen will be displayed:

```
RESISTIVE ENCODER:
1. CREATE NEW SETUP
2. LOAD SETUP
3. PRINT SETUP DIR
```

Press the **[3]** key (*PRINT SETUP DIR*). The setup directory will be printed and you will be returned to the "START-UP" menu. A sample resistor type transducer setup directory printout is shown in Figure 17.

RESISTIVE ENCODER SETUP DIRECTORY	
SETUP NUMBER 1	SETUP NOTE:
UNITS:	ENGLISH
SETTING:	2.465 INCHES/VDLT
SETUP NUMBER 2	SETUP NOTE:
UNITS:	ABB
SETTING:	ENGLISH 2.040 INCHES/VDLT
SETUP NUMBER 3	SETUP NOTE:
UNITS:	2U OR5 IN ENGLISH
SETTING:	0.249 INCHES/VDLT
SETUP NUMBER 4	SETUP NOTE:
UNITS:	OR5 U 24 IN ENGLISH
SETTING:	47.768 INCHES/VDLT
SETUP NUMBER 5	SETUP NOTE:
UNITS:	OR5 U 30 IN ENGLISH
SETTING:	59.874 INCHES/VDLT
SETUP NUMBER 6	SETUP NOTE:
UNITS:	1U 10MM METRIC
SETTING:	10.1 MM/VDLT
SETUP NUMBER 7	SETUP NOTE:
UNITS:	1U 50MM METRIC
SETTING:	49.3 MM/VDLT
SETUP NUMBER 8	SETUP NOTE:
UNITS:	5U 305MM MET METRIC
SETTING:	62.1 MM/VDLT
SETUP NUMBER 9	SETUP NOTE:
UNITS:	ABB AHMB ENGLISH
SETTING:	1.622 INCHES/VDLT

Figure 17. Sample Resistor Type Transducer Setup Directory

BREAKER TIMING RESULTS - 60 Hz				
SHOT NUMBER: 78				
DATE: 05/11/07 TIME: 09:39:19				
COMPANY: VANGUARD				
STATION: ONTARIO				
CIRCUIT: 123				
MFR: ITE				
MODEL: 14 4KU				
S/N: 12345				
OPERATOR: HAI				
TEST: OPEN				
CONTACT TIME				
CH	TIME	CYCLE	BOUNCE	WIPE
	<ms>		<ms>	<ms>
1	41.70	2.50	0.05	0.90
2	39.35	2.90	0.10	0.69
3	42.85	2.55	0.05	0.98
DELTA TIME <ms>: 4.50				
CT CHANNEL ANALYSIS				
	TIME	CYCLE		
	<ms>			
	0.00	0.00		
TRAVEL ANALYSIS T1				
STROKE	in	6.97		
SPEED	ft/s	7.55		
OVER-TRAVEL	in	0.00		
BOUNCE BACK	in	0.00		
<RESISTIVE ANALOG ENCODER>				
SPEED ANALYSIS:				
POINT 1	=	1.00 in		
POINT 2	=	5.00 in		
V1 NOMINAL VOLTAGE	=	56 VOLTS		
V1 MINIMUM VOLTAGE	=	50 VOLTS		
INITIATOR CURRENT	=	5.7 AMPS		
SHOT LENGTH:		1 SECOND		
INSERTION RESISTOR:		NO		
TRIGGER:		INTERNAL		

Resistive Type
Transducer Indicator

Figure 18. Sample Timing Report Using a Resistor Type Transducer

3.3 Performing Circuit Breaker Timing Tests

The CT-8000 S3 can initiate the breaker operation and perform a timing test on the following operations:

- OPEN
- CLOSE
- OPEN-CLOSE
- CLOSE-OPEN
- OPEN-CLOSE-OPEN

The CT-8000 S3 can start the OPEN-CLOSE operations without a delay or by using a programmable delay between the OPEN and CLOSE commands.

The CLOSE-OPEN operation can be started by the CT-8000 S3 using several options:

- Contact #1 CLOSE

The CT-8000 S3 can initiate a CLOSE command and then an OPEN command after detecting the closing of the breaker's contact. The CT-8000 S3 detects the closing of the contact through contact channel #1. This option is recommended for the CLOSE-OPEN operation since it truly represents when the circuit breaker closed and then opened.

- Set DELAY

The CT-8000 S3 can initiate a CLOSE command and then an OPEN command after a programmable delay set in milliseconds.

- No DELAY

The CT-8000 S3 can initiate a CLOSE command and then an OPEN command without any delay. Since the circuit breaker is in the OPEN state, the breaker's 52B contact allows the CLOSE coil to be energized, which can start the CLOSE command. When the circuit breaker is making the transition from an OPEN state to a CLOSE state, the 52A contact will close allowing the breaker to initiate the OPEN command.

The OPEN-CLOSE-OPEN operation can be initiated by the CT-8000 S3 by using a programmable delay between each of the operations. The delays can be set between the OPEN to CLOSE commands and between the CLOSE to OPEN commands.

3.3.1. Timing an OPEN Operation

The CT-8000 S3 can time breakers with or without insertion resistors. The insertion resistance can range from 10 to 5,000 Ohms. Any insertion resistance greater than 5,000 Ohms is detected as an open circuit. The timing results will show the main contact time and the insertion resistor contact time. Graphic reports will show the main contact and the resistor contact activities on each of the channels. Use the steps below to time an OPEN operation.

- a. When the unit is turned on and the firmware has been loaded, you will be presented with the "START-UP" menu as shown below:

```
1. RUN TEST      10/08/13
2. GET RESULTS   10:10:10
3. SAVE/RESTORE
4. SETUP
5. DIAGNOSTICS
```

Press the **[1]** key (*RUN TEST*).

- b. The following screen will be displayed:

```
1. TIME DRY CONTACTS
2. TIME LIVE CONTACTS
3. STATIC RES TEST
4. DYNAMIC RES TEST
```

Press the **[1]** key (*TIME DRY CONTACTS*).

- c. The following screen will be displayed:

```
INSERTION RESISTOR?

1. NO
2. YES
```

1. **NO**

Press the **[1]** key (*NO*) if you are timing a circuit breaker without insertion resistors.
Continue to step d.

2. **YES**

Press the **[2]** key (*YES*) if you are timing a circuit breaker with insertion resistors.
The following screen will be displayed:

```
RESISTOR VALUE:

1. LESS THAN 1000 OHMS
2. 1000 TO 2000 OHMS
3. MORE THAN 2000 OHMS
```

Select the resistance value by pressing the corresponding key (**[1]**, **[2]**, or **[3]**).

Continue to step d.

- d. The following screen will be displayed:

```
TIMING WINDOW:

1. WINDOW = 1 SEC
2. WINDOW = 10 SEC
3. WINDOW = 20 SEC
```

Press the **[1]** key (*WINDOW = 1 SEC*).



NOTE

The 1-second timing window is used for breaker timing. The 10 and 20-second timing windows are used for long timing events such as for timing circuit-switchers.

- e. The following screen will be displayed:

```
TRIGGER MODE:

1. INTERNAL TRIGGER
2. EXTERNAL TRIGGER
```

Press the **[1]** key (*INTERNAL TRIGGER*).

- f. The following screen will be displayed:

```
TIMING MODE:

1. OPEN      2. CLOSE
3. O-C      4. C-O
5. O-C-O
```

Press the **[1]** key (*OPEN*).

- g. The following screen will be displayed:

```
HOLD "ARM" UNTIL  
TEST COMPLETES.  
  
"START" TO BEGIN  
"STOP" TO ABORT
```

Hold down the **[ARM]** switch and press the **[START]** key.

- h. The following screen will be displayed:

```
TEST IN PROGRESS  
HOLD "ARM" UNTIL  
TEST COMPLETES.  
(UP TO 25 SECONDS)
```

Continue to hold down the **[ARM]** switch until testing is finished. You will be returned to the "START-UP" menu once testing is finished.

**NOTES**

- Please see section 3.3.5 for information about printing test results.
- The CT-8000 S3 can be configured to print tabulated and graphics reports automatically after performing a test. Please see section 3.2.3 for further information.

3.3.2. Timing a CLOSE-OPEN Operation

The CLOSE-OPEN operation of a breaker simulates a condition where a breaker is closed on a fault. There are three options when timing a CLOSE-OPEN operation:

1. Contact #1 CLOSE

The CT-8000 S3 will initiate a CLOSE operation. The open operation is then initiated after contact channel #1 is closed. This option closes simulates the breaker closing on a fault condition in the field.

2. Set DELAY

A delay from 10 to 500 ms can be set between the CLOSE command and the OPEN command. The CT-8000 S3 will initiate the CLOSE operation and start the delay counter. The OPEN operation will be initiated when the delay time has elapsed.

3. No DELAY

Both the CLOSE and OPEN commands are initiated by the CT-8000 S3 simultaneously. The OPEN coil is energized when the OPEN auxiliary switch makes.

Follow the steps below to time a CLOSE-OPEN operation:

- a. Start from the "START-UP" menu:

```
1. RUN TEST      10/08/13
2. GET RESULTS   10:10:10
3. SAVE/RESTORE
4. SETUP
5. DIAGNOSTICS
```

Press the **[1]** key (*RUN TEST*).

- b. The following screen will be displayed:

```
1. TIME DRY CONTACTS
2. TIME LIVE CONTACTS
3. STATIC RES TEST
4. DYNAMIC RES TEST
```

Press the **[1]** key (*TIME DRY CONTACTS*).

- c. The following screen will be displayed:

```
INSERTION RESISTOR?  
  
1. NO  
2. YES
```

Press the **[1]** key (*NO*).

- d. The following screen will be displayed:

```
TIMING WINDOW:  
  
1. WINDOW = 1 SEC  
2. WINDOW = 10 SEC  
3. WINDOW = 20 SEC
```

Press the **[1]** key (*WINDOW = 1 SEC*).

- e. The following screen will be displayed:

```
TRIGGER MODE:  
  
1. INTERNAL TRIGGER  
2. EXTERNAL TRIGGER
```

Press the **[1]** key (*INTERNAL TRIGGER*).

- f. The following screen will be displayed:

```
TIMING MODE:  
  
1. OPEN      2. CLOSE  
3. O-C      4. C-O  
5. O-C-O
```

Press the **[4]** key (*C-O*).

- g. The following screen will be displayed:

```
C-O SECOND TRIGGER:  
1. CONTACT #1 CLOSE  
2. SET DELAY  
3. NO DELAY
```

1. *Contact #1 CLOSE*

Press the **[1]** key if you would like the open operation to be initiated after contact channel #1 is closed. **Continue to step h.**

2. *Set DELAY*

Press the **[2]** key to set a delay time between the CLOSE command and the OPEN command. The following screen will be displayed:

```
C-O DELAY IN MS:  
  (10 - 500)  
      MSEC  
  
"ENTER" WHEN DONE
```

Type the delay time using the keypad and then press the **[ENTER]** key. **Continue to step h.**

3. *No DELAY*

Press the **[3]** key to initiate the CLOSE and OPEN commands simultaneously. **Continue to step g.**

- h. The following screen will be displayed:

```
HOLD "ARM" UNTIL  
TEST COMPLETES.  
  
"START" TO BEGIN  
"STOP" TO ABORT
```

Hold down the **[ARM]** switch and press the **[START]** key.

- i. The following screen will be displayed:

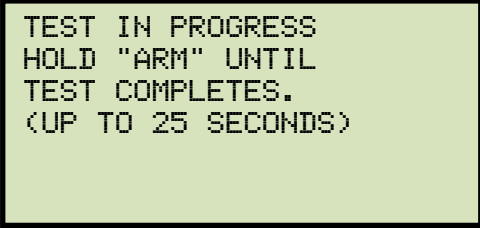

```
TEST IN PROGRESS
HOLD "ARM" UNTIL
TEST COMPLETES.
(UP TO 25 SECONDS)
```

Continue to hold down the **[ARM]** switch until testing is finished. You will be returned to the "START-UP" menu once testing is finished.

3.3.3. Timing an OPEN-CLOSE-OPEN Operation

The OPEN-CLOSE-OPEN operation requires the user to enter two time delays (in milliseconds) between the circuit breaker operations. The first delay is from the first OPEN command to the CLOSE command, and the second delay is from the CLOSE command to the second OPEN command. Follow the steps below to time an OPEN-CLOSE-OPEN operation:

- a. Start from the "START-UP" menu:

```
1. RUN TEST      10/08/13
2. GET RESULTS  10:10:10
3. SAVE/RESTORE
4. SETUP
5. DIAGNOSTICS
```

Press the **[1]** key (*RUN TEST*).

- b. The following screen will be displayed:

```
1. TIME DRY CONTACTS
2. TIME LIVE CONTACTS
3. STATIC RES TEST
4. DYNAMIC RES TEST
```

Press the **[1]** key (*TIME DRY CONTACTS*).

- c. The following screen will be displayed:

```
INSERTION RESISTOR?

1. NO
2. YES
```

Press the **[1]** key (*NO*).

- d. The following screen will be displayed:

```
TIMING WINDOW:

1. WINDOW = 1  SEC
2. WINDOW = 10 SEC
3. WINDOW = 20 SEC
```

Press the **[1]** key (*WINDOW = 1 SEC*).

- e. The following screen will be displayed:

```
TRIGGER MODE:  
  
1. INTERNAL TRIGGER  
2. EXTERNAL TRIGGER
```

Press the **[1]** key (*INTERNAL TRIGGER*).

- f. The following screen will be displayed:

```
TIMING MODE:  
  
1. OPEN      2. CLOSE  
3. O-C      4. C-O  
5. O-C-O
```

Press the **[5]** key (*O-C-O*).

- g. The following screen will be displayed:

```
O-C DELAY IN MS:  
  (10 - 350)  
      MSEC  
  
"ENTER" WHEN DONE
```

Using the keypad, enter the time for the delay between the first OPEN command and the CLOSE command. Press the **[ENTER]** key.

- h. The following screen will be displayed:

```
C-O DELAY IN MS:  
  (10 - 350)  
      MSEC  
  
"ENTER" WHEN DONE
```

Using the keypad, enter the time for the delay between the CLOSE command and the second OPEN command. Press the **[ENTER]** key.

- i. The following screen will be displayed:

```
HOLD "ARM" UNTIL  
TEST COMPLETES.  
  
"START" TO BEGIN  
"STOP" TO ABORT
```

Hold down the **[ARM]** switch and press the **[START]** key.

- j. The following screen will be displayed:

```
TEST IN PROGRESS  
HOLD "ARM" UNTIL  
TEST COMPLETES.  
(UP TO 25 SECONDS)
```

Continue to hold down the **[ARM]** switch until testing is finished. You will be returned to the "START-UP" menu once testing is finished. See Figure 19 and Figure 20 for a sample O-C-O test results graph and tabulated test results printout, respectively.

3.3.4. Performing an On-Line Timing Test on Live Contacts

The optional "On-line" timing mode (part no. 9103-OT) can be used to capture the breaker's trip or close time, the trip/close coil current "fingerprint", and the battery supply voltage while the breaker is still in service. The On-line timing mode requires an external trigger on the coil being tested.

Follow the steps below to perform an on-line timing test (an OPEN test example is shown below):

- a. Make the cable connections per Figure 8 and then start from the "START-UP" menu:

```
1. RUN TEST      10/08/13
2. GET RESULTS   10:10:10
3. SAVE/RESTORE
4. SETUP
5. DIAGNOSTICS
```

Press the **[1]** key (*RUN TEST*).

- b. The following screen will be displayed:

```
1. TIME DRY CONTACTS
2. TIME LIVE CONTACTS
3. STATIC RES TEST
4. DYNAMIC RES TEST
```

Press the **[2]** key (*TIME LIVE CONTACTS*).

- c. The following screen will be displayed:

```
TIMING MODE:
1. OPEN      2. CLOSE
3. O-C      4. C-O
```

Press the **[1]** key (*OPEN*).

- d. The following screen will be displayed:

```
-> NO INITIATE CABLES
-> EXTERNAL TRIGGER
    ONLY!

"START" TO BEGIN
"STOP" TO ABORT
```

Press the **[START]** key.

- e. The following screen will be displayed temporarily:

```
TESTING IN PROGRESS...
```

Then the following screen will be displayed:

```
AWAITING TRIGGER...
```

The unit will wait for the external trigger.

- f. Once an external trigger is sensed, the test results will be stored in the working memory and you will be returned to the "START-UP" menu. Use the instructions in section 3.3.5 to print the test results. Sample on-line timing test results printouts are shown in Figure 21 and Figure 22.

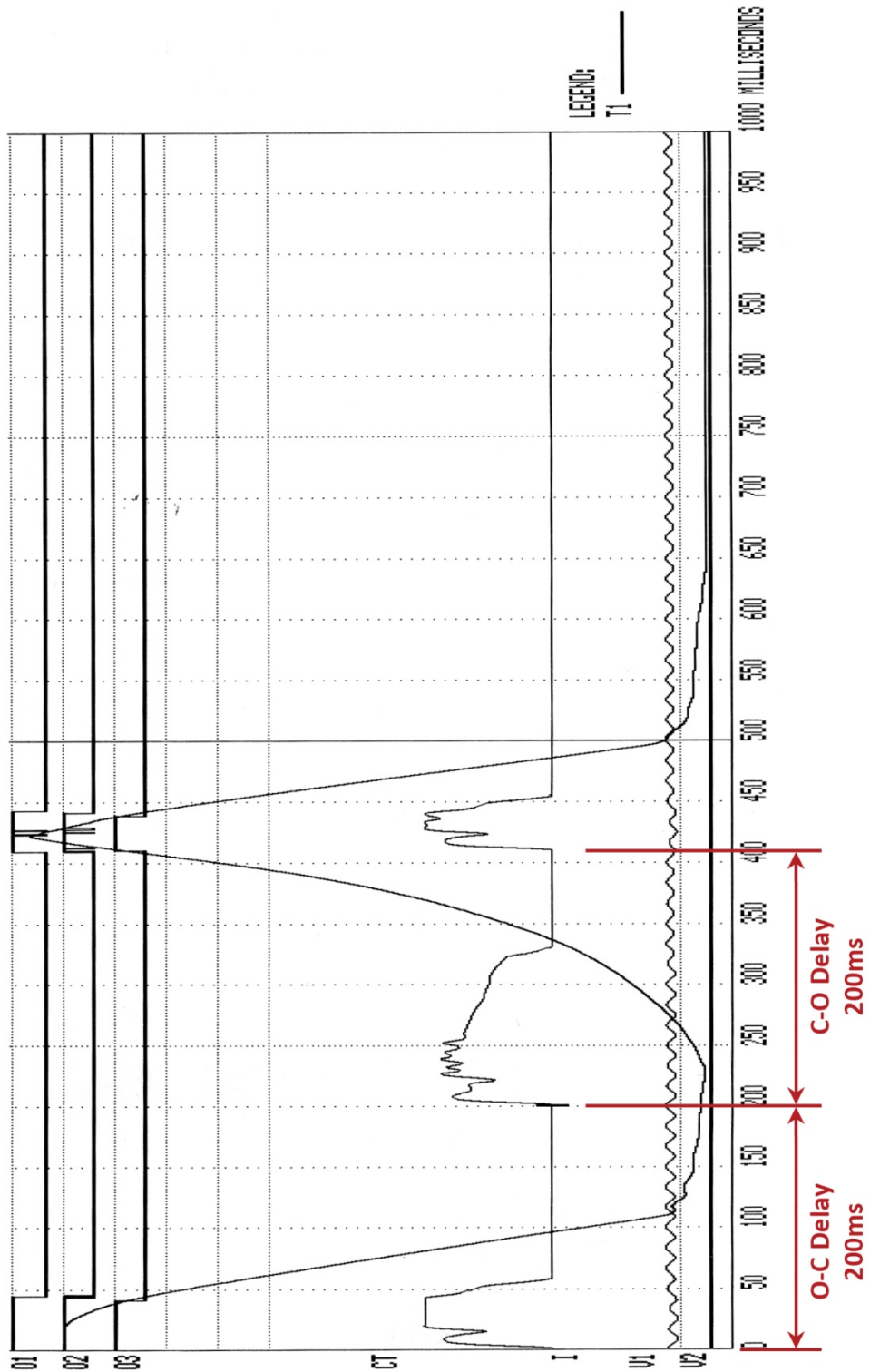

Figure 19. Typical O-C-O Test Results Graph

BREAKER TIMING RESULTS - 60 Hz			
SHOT NUMBER: 10			
DATE: 08/17/13 TIME: 14:29:85			
COMPANY: VANGUARD			
STATION: ONTARIO			
CIRCUIT: 123			
MFR:			
MODEL: CT-8000			
S/N: 81002			
OPERATOR: HAI			
TEST: OPEN-CLOSE-OPEN			
CONTACT OPEN TIME #1			
CH	TIME <ms>	CYCLES	BOUNCE <ms>
1	43.70	2.62	0.10
2	42.70	2.56	2.95
3	40.40	2.42	0.10
CONTACT RECLOSE TIME			
CH	TIME <ms>	CYCLES	BOUNCE <ms>
1	408.45	24.51	1.15
2	408.15	24.49	4.00
3	407.65	24.46	2.80
CONTACT OPEN TIME #2			
CH	TIME <ms>	CYCLES	BOUNCE <ms>
1	442.10	26.53	0.25
2	440.90	26.45	1.95
3	437.85	26.27	0.95
CONTACT DEAD TIME			
CH	TIME <ms>	CYCLES	
1	364.75	21.88	
2	365.45	21.93	
3	367.25	22.01	
CONTACT LIVE TIME			
CH	TIME <ms>	CYCLES	
1	33.65	2.02	
2	32.75	1.95	
3	30.20	1.81	
PEAK TO PEAK TRAVEL <in>			
T1			
7.02			
U1 NOMINAL VOLTAGE = 56 VOLTS			
U1 MINIMUM VOLTAGE = 50 VOLTS			
INITIATOR CURRENT = 5.7 AMPS			
SHOT LENGTH: 1 SECOND			
INSERTION RESISTOR: NO			
TRIGGER: INTERNAL			
O-C DELAY: 200 ms			
C-O DELAY: 200 ms			

Figure 20. Typical Tabulated Test Results Printout for an O-C-O Operation

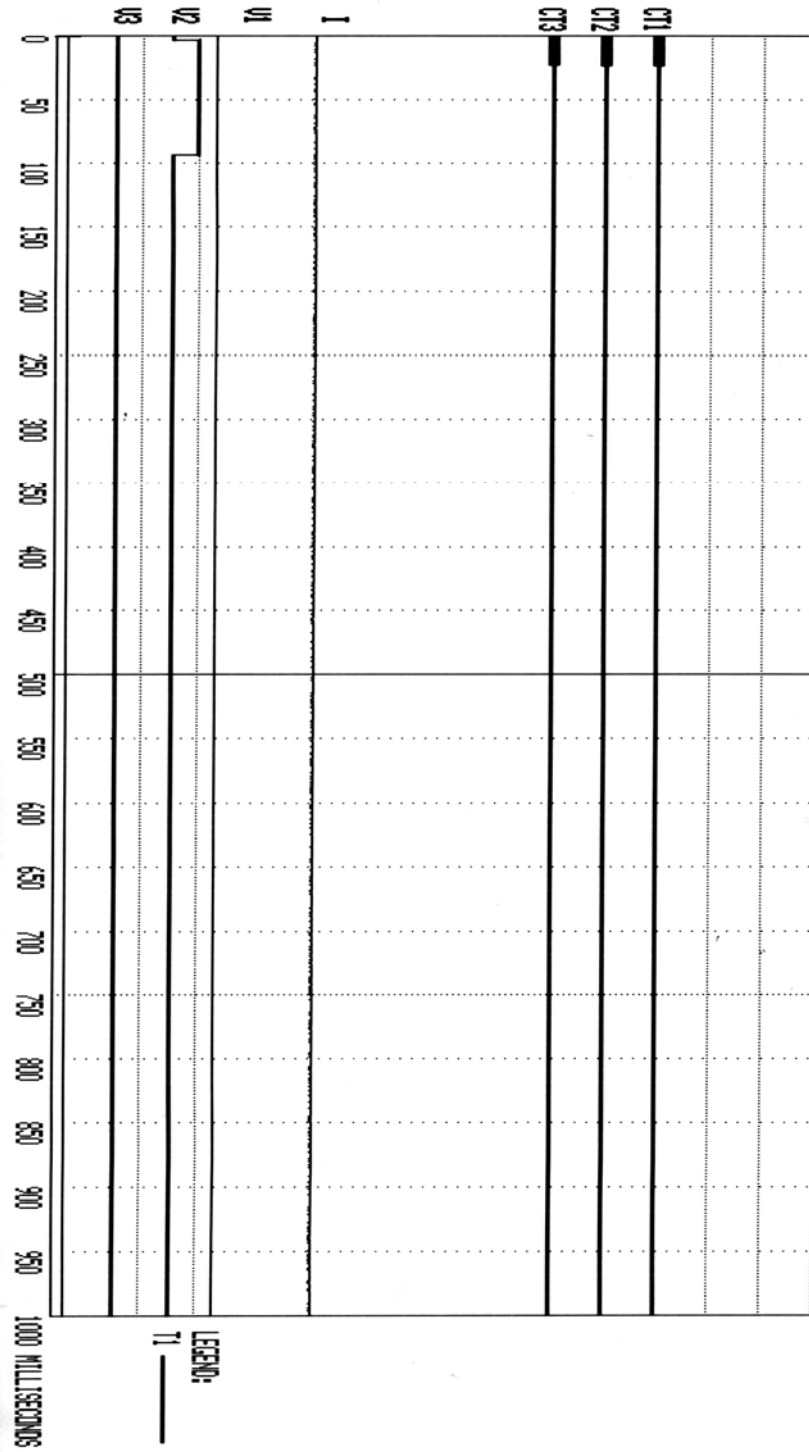

Figure 21. Typical On-Line Timing Test Graph Printout

BREAKER TIMING RESULTS - 60 Hz			
SHOT NUMBER: 2			
DATE: 10/02/13		TIME: 10:33:55	
COMPANY:	UIC		
STATION:	LAB		
CIRCUIT:			
MFR:			
MODEL:	CT 7000 S3		
S/N:	130018		
OPERATOR:	LU		
TEST: LIVE OPEN			
CT CHANNEL ANALYSIS			
CH	TIME	CYCLES	
	^	V	
1	22.65	1.96	
2	22.75	1.96	
3	22.45	1.95	
U1 NOMINAL VOLTAGE = 0 VOLTS			
U1 MINIMUM VOLTAGE = 0 VOLTS			
U2/U3 TRANSITION TIMES			
	U2		U3
T1:	22.70	30	ZZ
T2:	22.75	30	ZZ
T3:	Z/A		Z/A
INITIATOR CURRENT = 0.0 AMPS			

Figure 22. Typical On-Line Timing Test Results Printout

3.3.5. Performing a Static Resistance Test

The CT-8000 S3 can also be used as a 200 Ampere micro-ohmmeter. Follow the steps below to perform a static resistance test:

- a. Start from the "START-UP" Menu:

```
1. RUN TEST      10/08/13
2. GET RESULTS  10:10:10
3. SAVE/RESTORE
4. SETUP
5. DIAGNOSTICS
```

Press the **[1]** key (*RUN TEST*).

- b. The following screen will be displayed:

```
1. TIME DRY CONTACTS
2. TIME LIVE CONTACTS
3. STATIC RES TEST
4. DYNAMIC RES TEST
```

Press the **[3]** key (*STATIC RES TEST*).

- c. The following screen will be displayed:

```
STATIC RES TEST
CONNECT DCR CABLES
THEN
"ENTER" TO BEGIN
```

Press the **[ENTER]** key.

- d. The following screen will be displayed momentarily:

```
CABLES ENERGIZED!
```

Once the test is complete, the results will be displayed as shown below:

```
TEST COMPLETE

RES = 291.6 μ-OHMS
CUR = 205.9 A
```

Press any key to return to the "START-UP" menu. You can print the test results using the instructions in section 3.3.7. A typical static resistance report is shown in Figure 23.

BREAKER TIMING RESULTS - 60 Hz	
SHOT NUMBER: 76	
DATE: 09/30/13	TIME: 09:15:51
COMPANY: UANGUARD	
STATION: ONTARIO	
CIRCUIT: 123	
MFR: ITE	
MODEL: 14 4KV	
S/N: 12345	
OPERATOR: HAI	
TEST: STATIC RES TEST	
TEST CURRENT: 205.9 AMPS	
RESISTANCE: 291.6 μ-OHMS	

Figure 23. Typical Static Resistance Test Report

3.3.6. Performing a Dynamic Resistance Test

The Dynamic Resistance Test can graph the circuit breaker contact resistance during the circuit breaker operation and can help detect circuit contact problems during operation. Follow the steps below to perform a Dynamic Resistance Test:



NOTES

- Please make connections per Figure 6.
- Only one dynamic resistance channel is available at a time. Other timing channels will remain active.

- a. Start from the "START-UP" menu:

```
1. RUN TEST      10/08/13
2. GET RESULTS  10:10:10
3. SAVE/RESTORE
4. SETUP
5. DIAGNOSTICS
```

Press the **[1]** key (*RUN TEST*).

- b. The following screen will be displayed:

```
1. TIME DRY CONTACTS
2. TIME LIVE CONTACTS
3. STATIC RES TEST
4. DYNAMIC RES TEST
```

Press the **[4]** key (*DYNAMIC RES TEST*).

- c. The following screen will be displayed:

```
INSERTION RESISTOR?

1. NO
2. YES
```

1. NO

Press the **[1]** key (*NO*) if you are timing a circuit breaker without insertion resistors.
Continue to step d.

2. YES

Press the **[2]** key (*YES*) if you are timing a circuit breaker with insertion resistors.
The following screen will be displayed:

```
RESISTOR VALUE:

1. LESS THAN 1000 OHMS
2. 1000 TO 2000 OHMS
3. MORE THAN 2000 OHMS
```

Select the resistance value by pressing the corresponding key (**[1]**, **[2]**, or **[3]**).

Continue to step d.

- d. The following screen will be displayed:

```
TRIGGER MODE:

1. INTERNAL TRIGGER
2. EXTERNAL TRIGGER
```

Press the **[1]** key (*INTERNAL TRIGGER*).

- e. The following screen will be displayed:

```
TIMING MODE:

1. OPEN      2. CLOSE
3. O-C      4. C-O
5. O-C-O
```

Press the **[1]** key (*OPEN*).

- f. The following screen will be displayed:

```
HOLD "ARM" UNTIL
TEST COMPLETES.

"START" TO BEGIN
"STOP" TO ABORT
```

Hold down the **[ARM]** switch and press the **[START]** key.

- g. The following screen will be displayed:

```
TEST IN PROGRESS
HOLD "ARM" UNTIL
TEST COMPLETES.
(UP TO 25 SECONDS)
```

Continue to hold down the **[ARM]** switch until testing is finished. You will be returned to the "START-UP" menu once testing is finished. You will be returned to the "START-UP" menu once testing is finished.

See section 3.3.7 for instructions on how to print the test results and graph. Dynamic Resistance Graphs are shown in Figure 24, Figure 25, and Figure 26.



When printing the dynamic test results, the timing graph will also be printed after the dynamic resistance graph.

NOTE

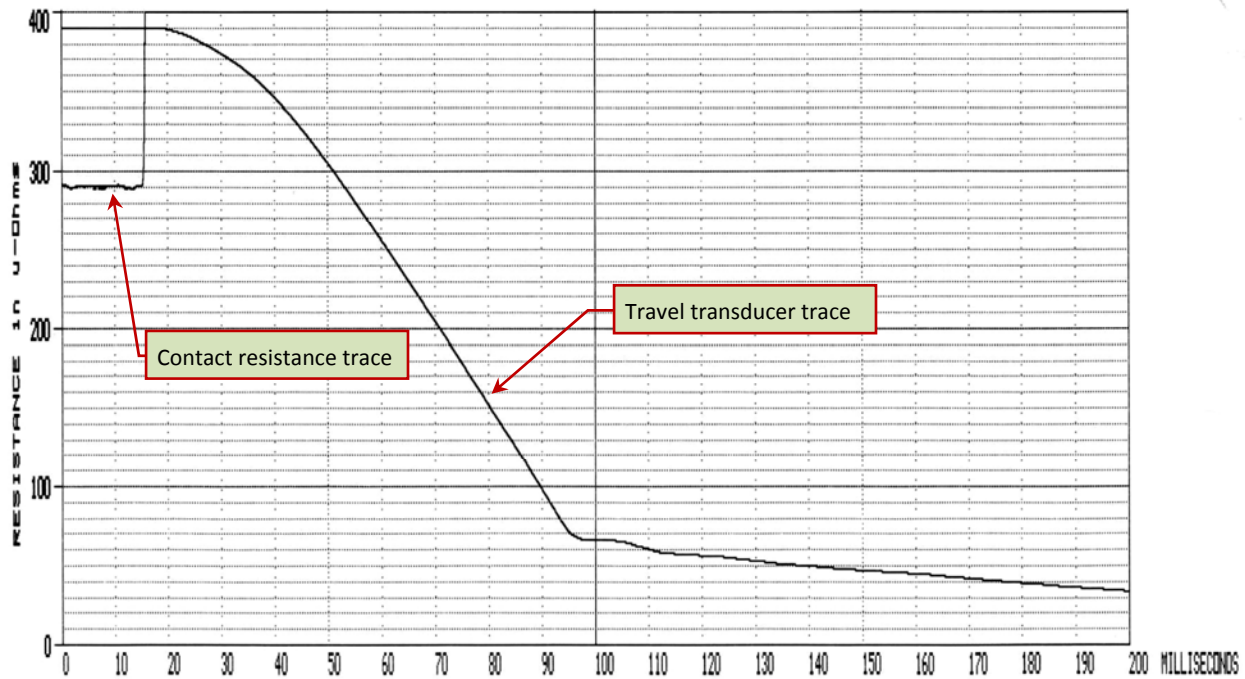

Figure 24. Dynamic Resistance Graph (0 - 400 micro-ohm linear scale)

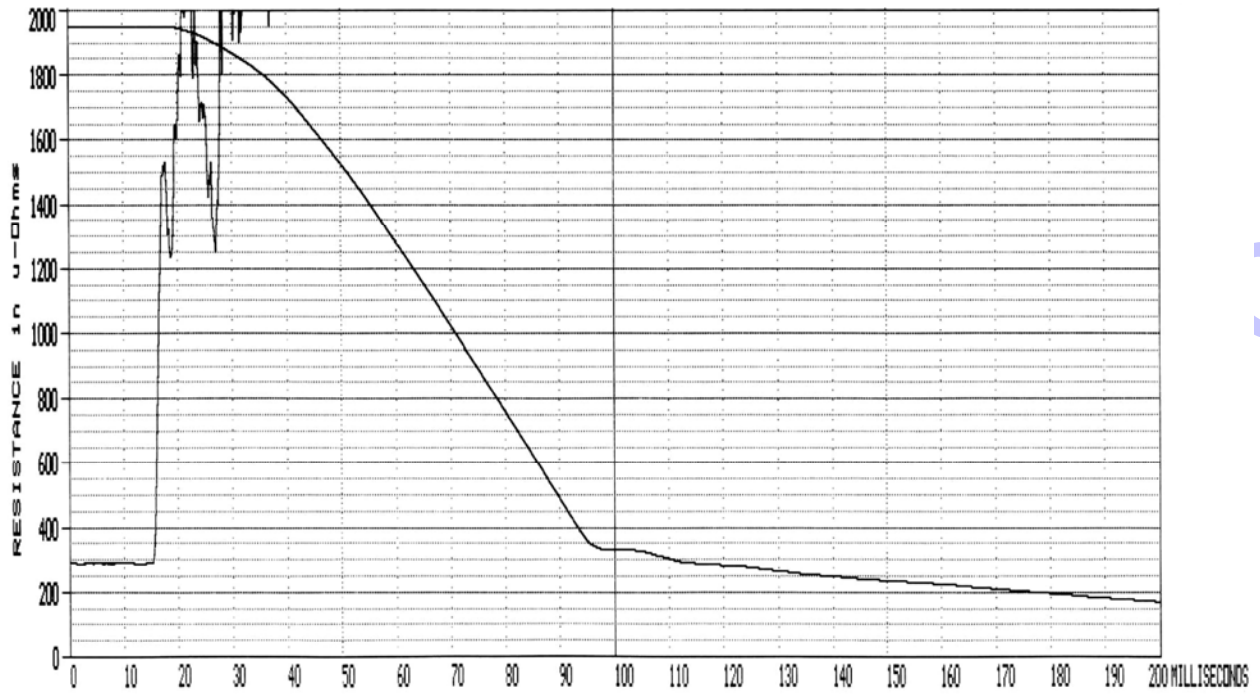

Figure 25. Dynamic Resistance Graph (0 - 2000 micro-ohm linear scale)

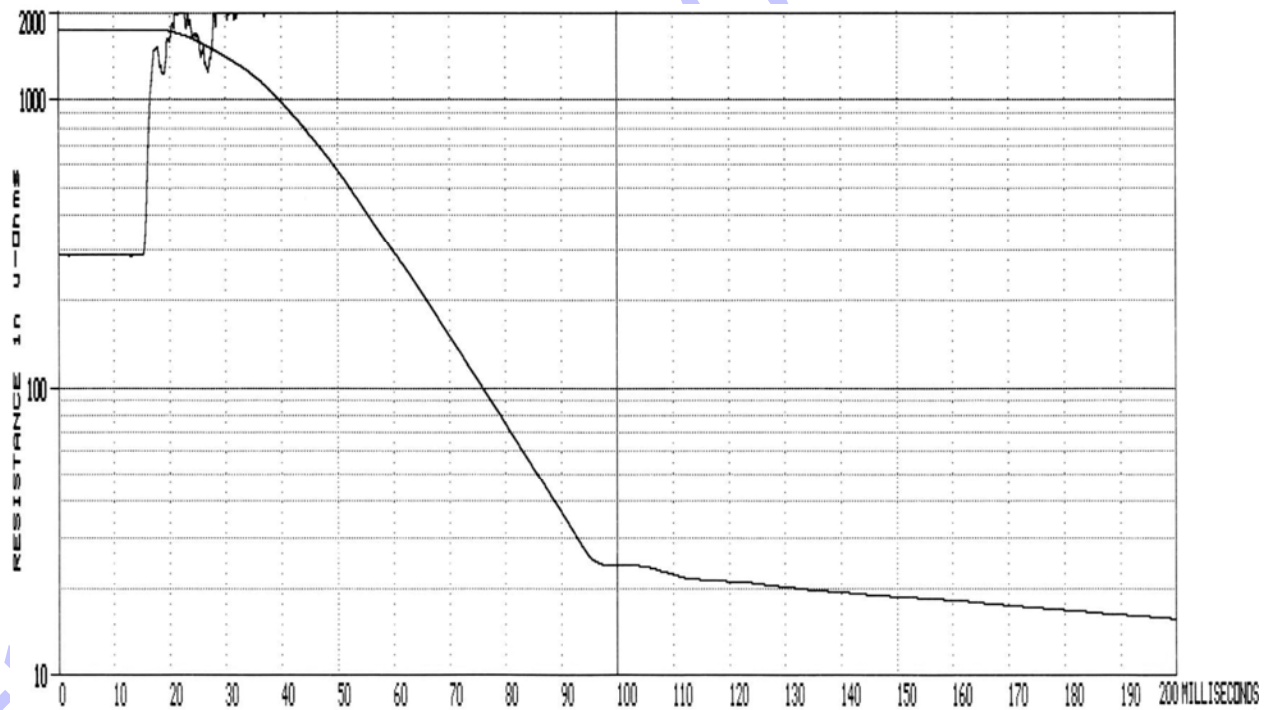

Figure 26. Dynamic Resistance Graph in Semi-Log Scale

3.3.7. Printing or Viewing Timing Results

Follow the steps below to print or view the timing results after performing a circuit breaker timing test:

- a. After performing a timing test you will be returned to the “START-UP” menu:

```
1. TIME BREAKER 09/16/13
2. GET RESULTS 10:10:10
3. SAVE/RESTORE
4. SETUP
5. DIAGNOSTICS
```

Press the **[2]** key (*GET RESULTS*).

- b. The following screen will be displayed:

```
1. PRINT TEST RESULTS
2. PLOT FULL CHART
3. PLOT EXPANSION
4. PLOT 0 - 200MS
```



If you are printing the results of a dynamic resistance test, press the **[2]** key (*PLOT FULL CHART*), **[3]** key (*PLOT EXPANSION*), or **[4]** key (*PLOT 0 - 200MS*) and then follow the instructions on page 77.

NOTE

1. *PRINT TEST RESULTS*

Press the **[1]** key (*PRINT TEST RESULTS*) to view the test results on the screen or to print the tabulated test results *WITHOUT* the graph. The following screen will be displayed:

```
SELECT PRINTER

1. THERMAL PRINTER
2. DISPLAY RESULTS
```

Press the **[1]** key (*THERMAL PRINTER*) to print the tabulated test results on the built-in thermal printer. The tabulated results will be printed, and you will be returned to the “START-UP” menu. A typical tabulated results printout is shown in Figure 27.

Press the **[2]** key (*DISPLAY RESULTS*) to display the test results on the unit's LCD screen. The following screen will be displayed:

```
UP / DWN ARROWS TO
SCROLL RESULTS...

"STOP" TO EXIT...
```

Press the **[▲]** and **[▼]** keys to scroll through the test results. Press the **[STOP]** key to return to the "START-UP" menu.

2. PLOT FULL CHART

Press the **[2]** key (*PLOT FULL CHART*) to print the tabulated results WITH the full graph of the results. You will be returned to the "START-UP" menu when printing is finished. A typical test result graph is shown in Figure 28.

3. PLOT EXPANSION

Press the **[3]** key (*PLOT EXPANSION*) to print the tabulated results along with a time expansion plot of the test results. The following screen will be displayed:

```
EXPANSION FROM:
```

You will be asked to enter the start point for the expansion. The start point can be selected in 100 millisecond increments by typing the first digit of the starting time. For example, to select 500ms, simply press the **[5]** key. The screen will be updated as shown:

```
EXPANSION FROM:
500MS

"ENTER" TO CONFIRM
```

Press the **[ENTER]** key.

The following screen will be displayed:

```
EXPANSION TO:
```

Enter the end point for the expansion by typing the first digit of the 100 millisecond increment. For example, to select 900ms, press the **[9]** key. The screen will be updated as shown:

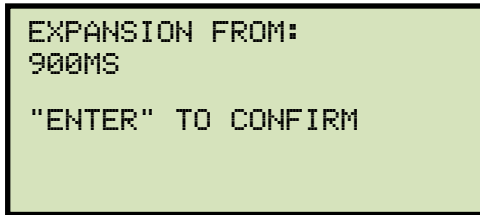

```
EXPANSION FROM:  
900MS  
"ENTER" TO CONFIRM
```

Press the **[ENTER]** key.

The graph expansion will be printed along with the tabulated test results. You will be returned to the "START-UP" menu when printing is finished.

4. *PLOT 0 – 200MS*

Press the **[4]** key (*PLOT 0 - 200MS*) to print the tabulated test results along with the graphic test results from 0 – 200 milliseconds. The graph and tabulated results will be printed on the thermal printer. You will be returned to the "START-UP" menu when printing is finished. A sample expansion graph from 0-200 ms is shown in Figure 29.



NOTE

If you are printing the results of a dynamic resistance test and you had selected option **[2]** (PLOT FULL CHART), **[3]** (PLOT EXPANSION), or **[4]** (PLOT 0 - 200 MS), the following screen will be displayed:

```

DYNAMIC RES PLOT
1. 0 - 400 μ-OHMS
2. 0 - 2000 μ -OHMS
3. 10 - 2000 SEMILOG
    
```

The Dynamic Resistance graph can be printed with a 0 to 400 micro-ohm linear scale, a 0 to 2000 micro-ohm linear scale, or a 10 to 2000 micro-ohm semi-log scale. Select your preferred graph type by pressing the corresponding key on the keypad. The test results will be printed and you will be returned to the "START-UP" menu.

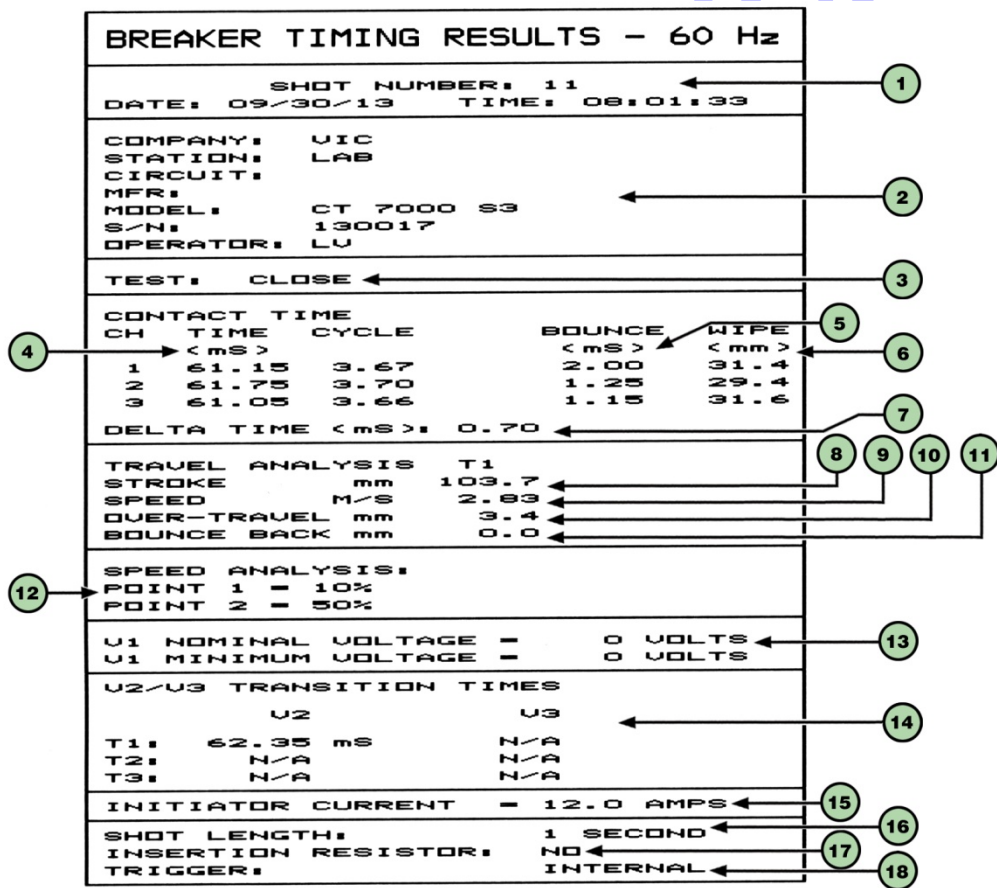

Figure 27. Typical Tabulated Test Results Printout for a CLOSE Operation

Table 3. Descriptions of Tabulated Test Results Elements

Item Number	Description
1	Test record number and the date and time the test was performed.
2	Test record header information (Company, Station, Circuit, etc.).
3	Type of test performed (OPEN, CLOSE, O-C, C-O, or O-C-O).
4	Contact channel times shown in milliseconds and cycles.
5	Contact channel bounce times shown in milliseconds.
6	Contact channel wipe distances in inches.
7	Contact delta time in milliseconds. This is the difference between the slowest contact time and the fastest contact time.
8	Breaker contact stroke in inches.
9	Contact velocity in feet per second.
10	Contact over-travel distance in inches.
11	Contact bounce-back distance in inches.
12	Contact velocity calculation points.
13	DC power supply nominal and minimum voltage (if DC power supply was monitored during testing).
14	V2/V3 voltage sensing channel transition times
15	Initiate current.
16	Timing shot duration.
17	Insertion time (if breaker had an insertion resistor) or "NO" if there was no resistor.
18	Trigger mode (Internal or External)

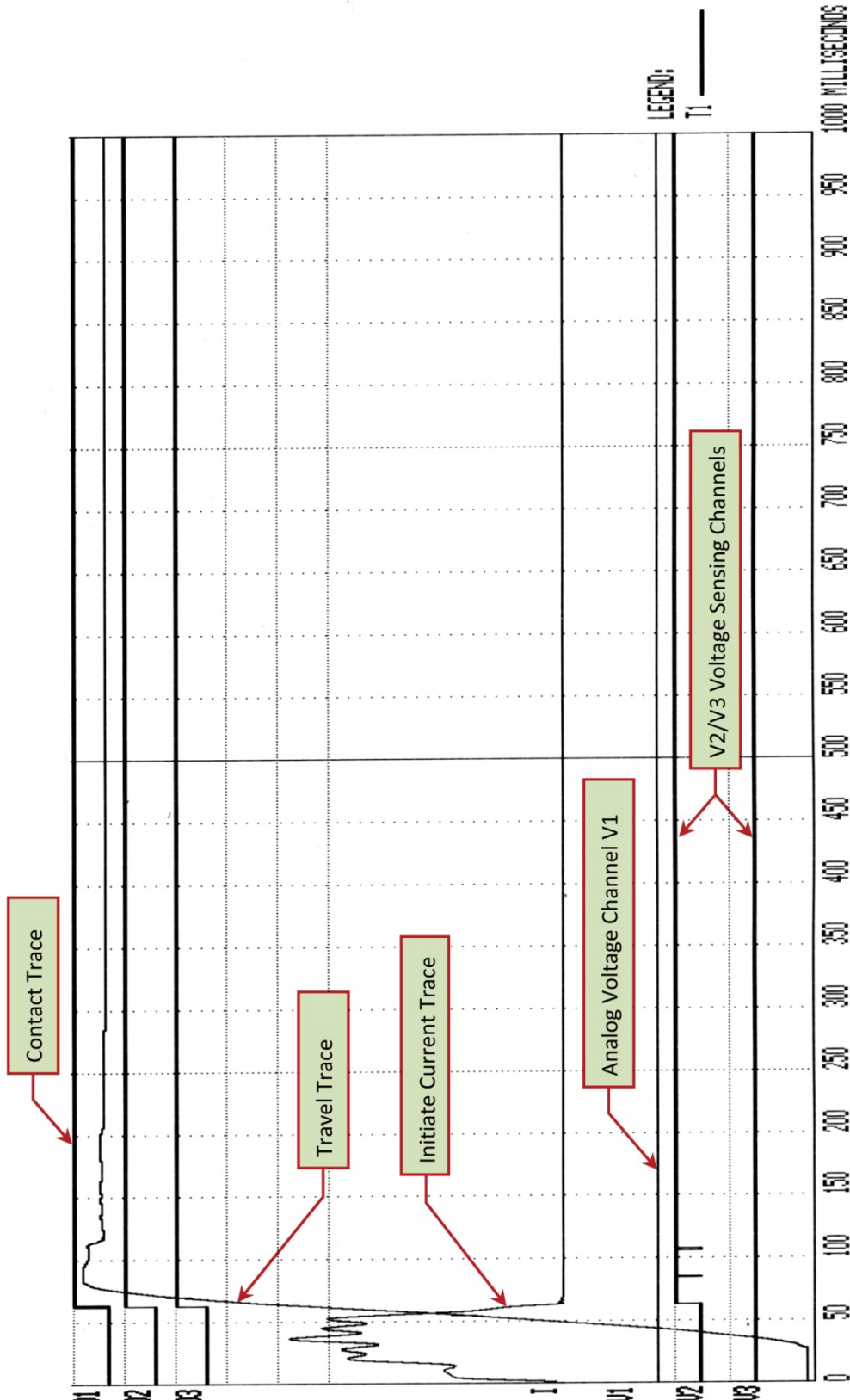

Figure 28. Typical Test Results Graph (CB CLOSE Test)

httr

.com

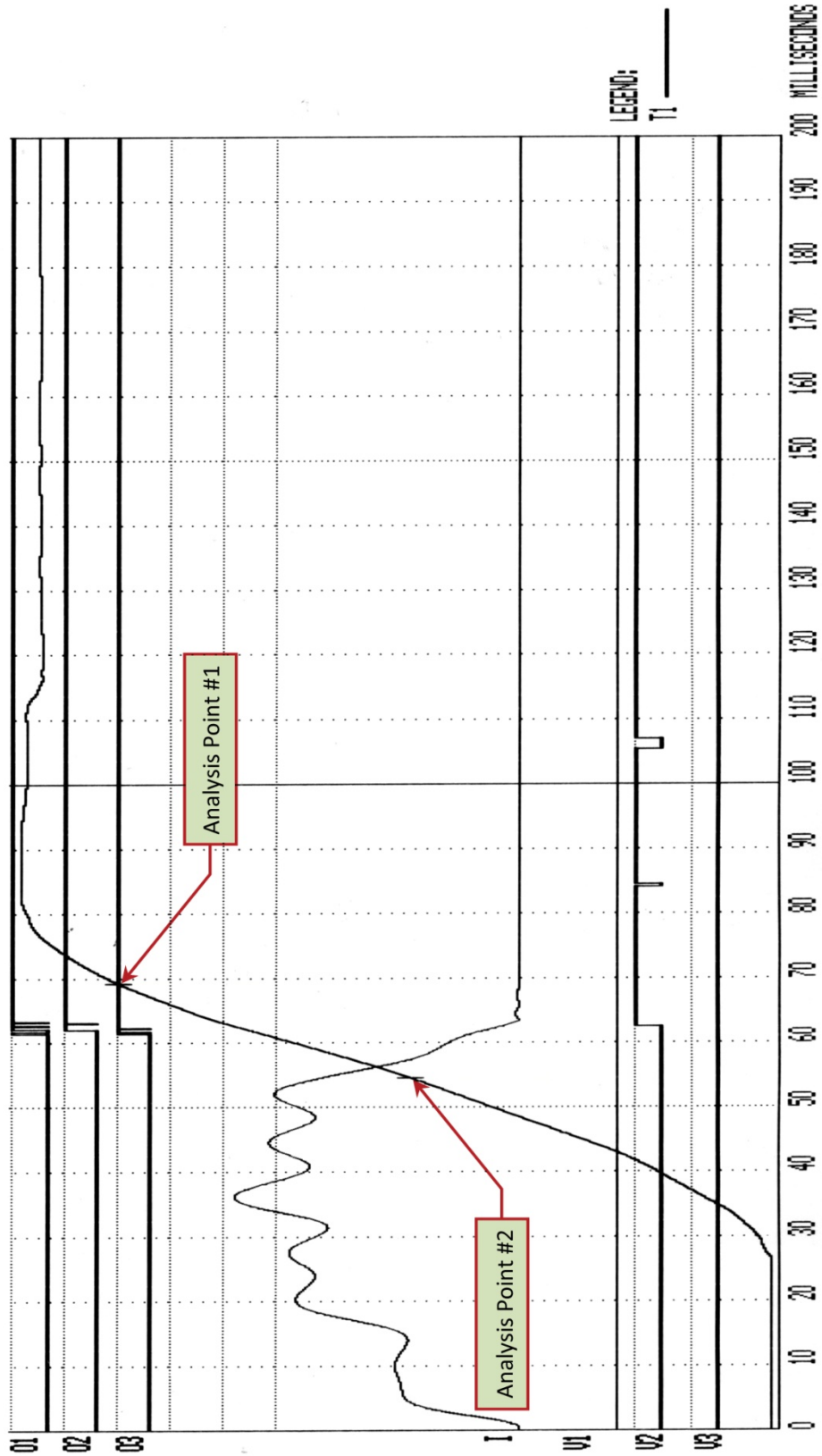

Figure 29. Expansion Graph from 0ms to 200ms (CB CLOSE Test)

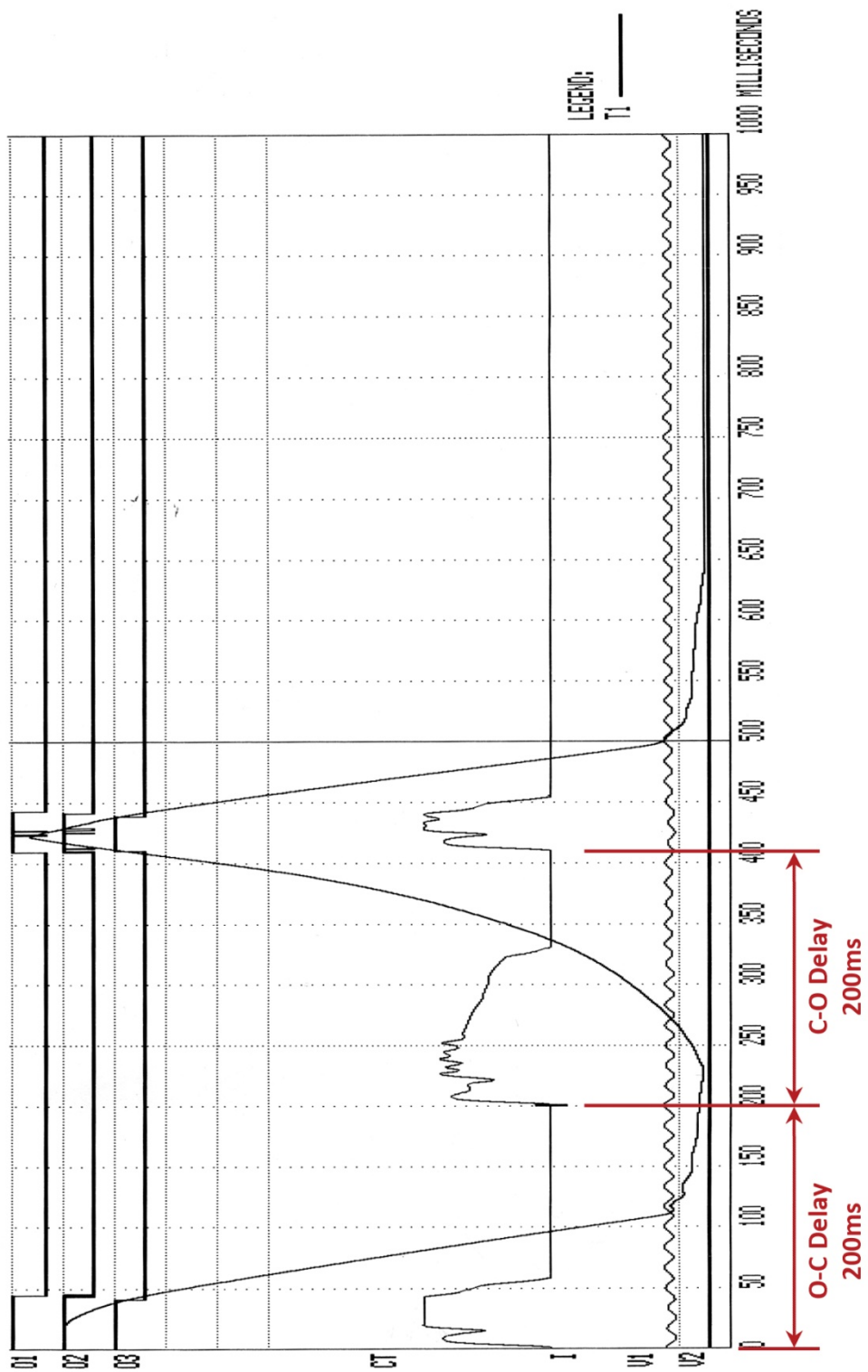
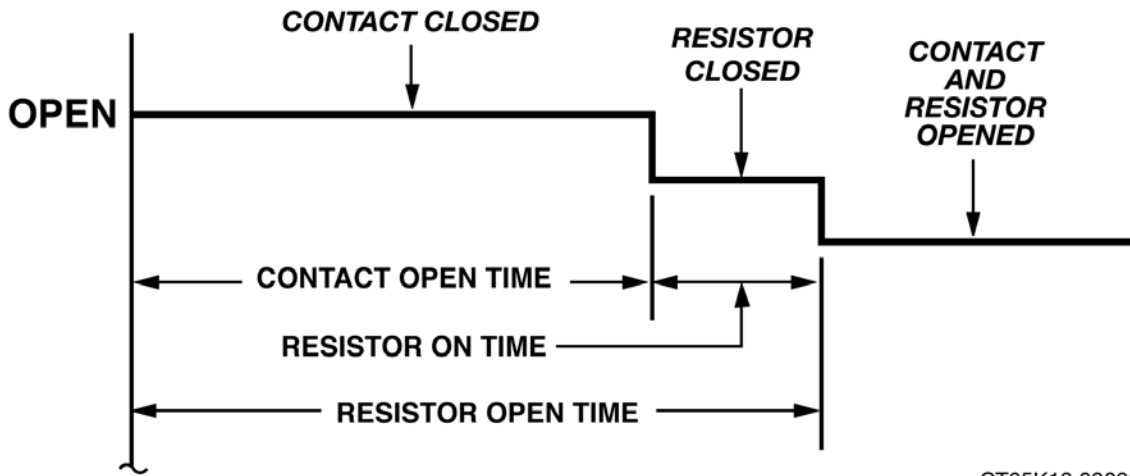

Figure 30. Typical O-C-O Test Results Graph

BREAKER TIMING RESULTS - 60 Hz			
SHOT NUMBER: 10			
DATE: 02/17/10 TIME: 14:29:85			
COMPANY: VANGUARD			
STATION: ONTARIO			
CIRCUIT: 123			
MFR:			
MODEL: CT-8000			
S/N: 81002			
OPERATOR: HAI			
TEST: OPEN-CLOSE-OPEN			
CONTACT OPEN TIME #1			
CH	TIME <ms>	CYCLES	BOUNCE <ms>
1	43.70	2.62	0.10
2	42.70	2.56	2.95
3	40.40	2.42	0.10
CONTACT RECLOSE TIME			
CH	TIME <ms>	CYCLES	BOUNCE <ms>
1	408.45	24.51	1.15
2	408.15	24.49	4.00
3	407.65	24.46	2.80
CONTACT OPEN TIME #2			
CH	TIME <ms>	CYCLES	BOUNCE <ms>
1	442.10	26.53	0.25
2	440.90	26.45	1.95
3	437.85	26.27	0.95
CONTACT DEAD TIME			
CH	TIME <ms>	CYCLES	
1	364.75	21.88	
2	365.45	21.93	
3	367.25	22.01	
CONTACT LIVE TIME			
CH	TIME <ms>	CYCLES	
1	33.65	2.02	
2	32.75	1.95	
3	30.20	1.81	
PEAK TO PEAK TRAVEL <in>			
T1			
7.02			
U1 NOMINAL VOLTAGE = 56 VOLTS			
U1 MINIMUM VOLTAGE = 50 VOLTS			
INITIATOR CURRENT = 5.7 AMPS			
SHOT LENGTH: 1 SECOND			
INSERTION RESISTOR: NO			
TRIGGER: INTERNAL			
O-C DELAY: 200 ms			
C-O DELAY: 200 ms			

Figure 31. Typical Tabulated Test Results Printout for an O-C-O Operation



CT65K13.030902

Figure 32. Graphical Interpretation of an OPEN Timing Shot

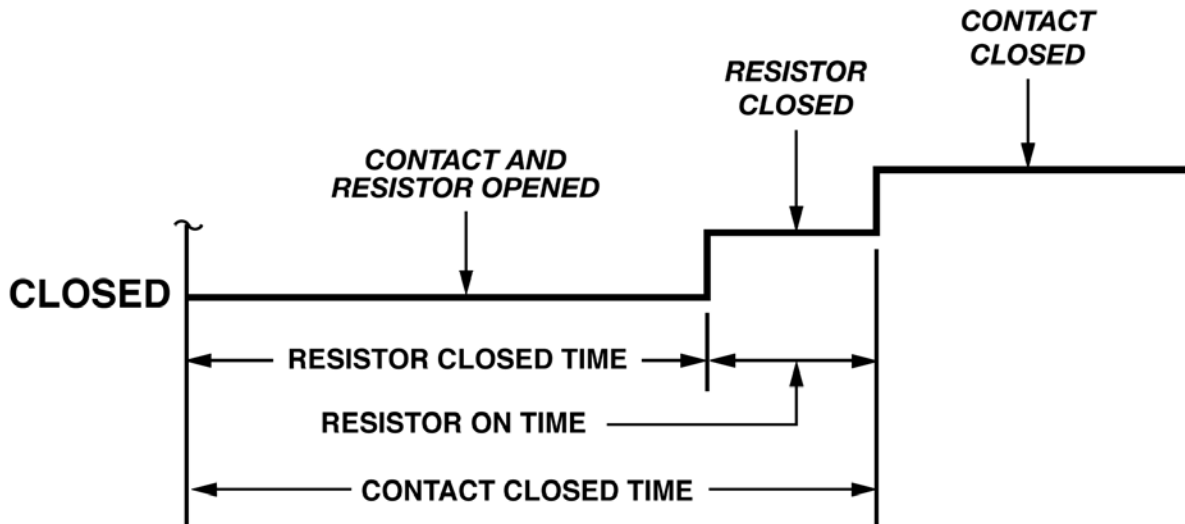

CT65K14.030902

Figure 33. Graphical Interpretation of a CLOSE Timing Shot

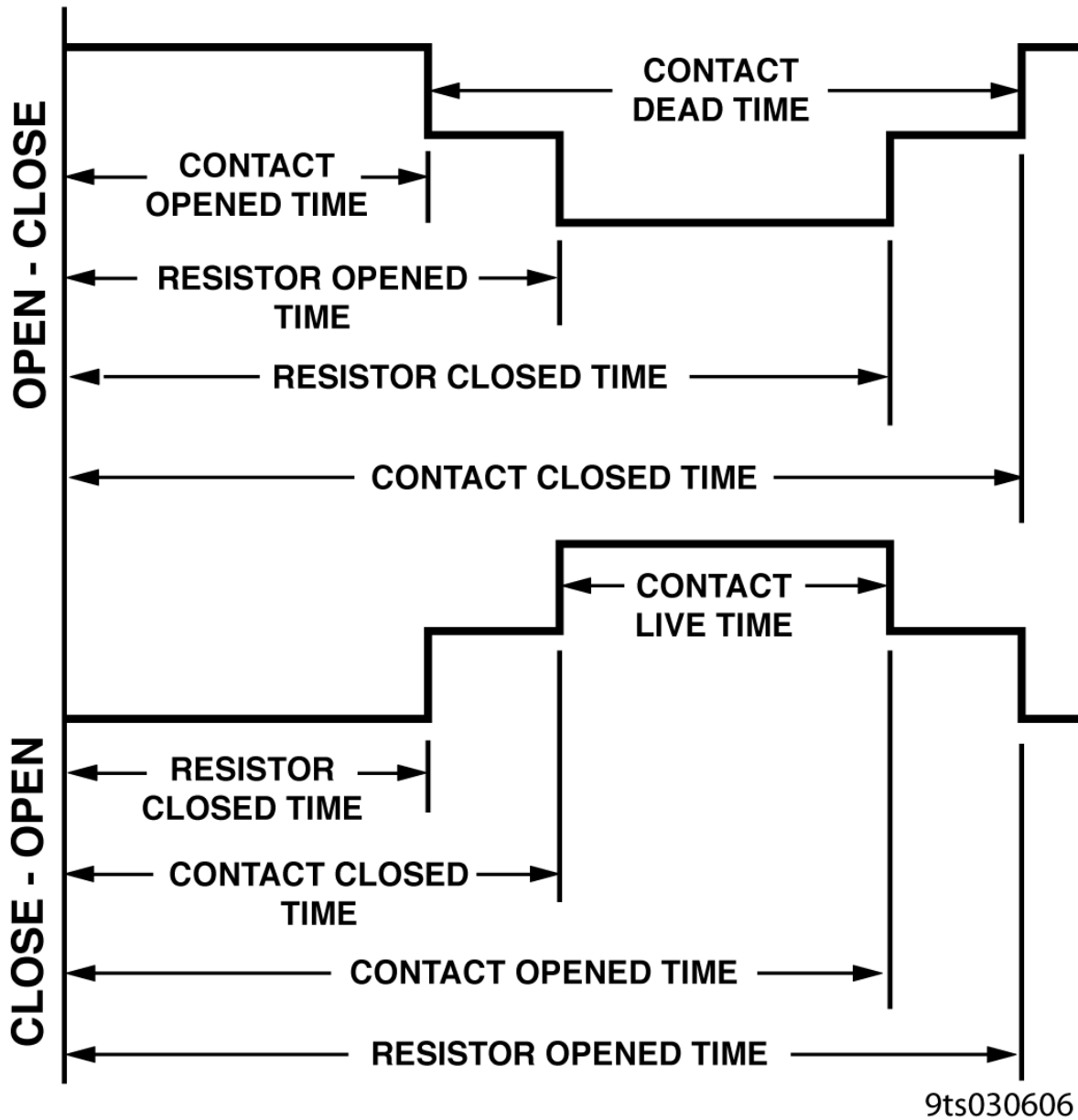

Figure 34. Graphical Interpretations of an OPEN-CLOSE and CLOSE-OPEN Timing Shot

3.4 Working with Test Records

3.4.1. Saving a Timing Record in Flash EEPROM

After performing a test, you can store the results in the CT-8000 S3's Flash EEPROM. To save a test record:

- a. Start from the "START-UP" menu:

```
1. RUN TEST      10/09/13
2. GET RESULTS  15:10:05
3. SAVE/RESTORE
4. SETUP
5. DIAGNOSTICS
```

Press the **[3]** key (*SAVE/RESTORE*).

- b. The following screen will be displayed:

```
1. SAVE SHOT
2. RESTORE SHOT
3. SHOT DIRECTORY
4. ERASE SHOT
```

Press the **[1]** key (*SAVE SHOT*).

- c. The following screen will be displayed:

```
SAVE SHOT #1
TEST: LIVE OPEN
DATE: 09/17/13  10:29

"ENTER" TO PROCEED
```

Press the **[ENTER]** key to save the test shot.

- d. The following screen will be displayed:

```
SHOT SAVED
```

Press any key to return to the "START-UP" menu.

3.4.2. Printing a Directory of Test Records Stored in the CT-8000 S3's Memory

You can print a directory of all the test records stored in the CT-8000 S3's Flash EEPROM by using the steps below:

- a. Start from the "START-UP" menu:

```
1. RUN TEST      10/09/13
2. GET RESULTS   10:10:10
3. SAVE/RESTORE
4. SETUP
5. DIAGNOSTICS
```

Press the **[3]** key (*SAVE/RESTORE*).

- b. The following screen will be displayed:

```
1. SAVE SHOT
2. RESTORE SHOT
3. SHOT DIRECTORY
4. ERASE SHOT
```

Press the **[3]** key (*SHOT DIRECTORY*).

- c. The following screen will be displayed:

```
1. SHORT DIRECTORY
2. FULL DIRECTORY
```

```
"STOP" TO QUIT
```

Press the **[1]** key (*SHORT DIRECTORY*) to print a directory of the last ten shots stored in the EEPROM. The short directory will be printed, and you will be returned to the "START-UP" menu.

Press the **[2]** key (*FULL DIRECTORY*) to print a directory of all the shots stored in the EEPROM. The full directory will be printed, and you will be returned to the "START-UP" menu.

A sample test record directory is shown in Figure 35.

TIMING SHOT ABBREVIATED DIRECTORY			
SHOT NUMBER: 14			
DATE	: 09/30/13	TIME	: 08:07:22
COMPANY	: UIC	MFGR	:
STATION	: LAB	MODEL	: CT 7000 S3
CIRCUIT	:	SERIAL	: 130017
OPERATOR	: LU	TEST	: OPEN-CLOSE-OPEN
SHOT NUMBER: 13			
DATE	: 09/30/13	TIME	: 08:04:23
COMPANY	: UIC	MFGR	:
STATION	: LAB	MODEL	: CT 7000 S3
CIRCUIT	:	SERIAL	: 130017
OPERATOR	: LU	TEST	: CLOSE - OPEN
SHOT NUMBER: 12			
DATE	: 09/30/13	TIME	: 08:02:56
COMPANY	: UIC	MFGR	:
STATION	: LAB	MODEL	: CT 7000 S3
CIRCUIT	:	SERIAL	: 130017
OPERATOR	: LU	TEST	: OPEN - CLOSE
SHOT NUMBER: 11			
DATE	: 09/30/13	TIME	: 08:01:33
COMPANY	: UIC	MFGR	:
STATION	: LAB	MODEL	: CT 7000 S3
CIRCUIT	:	SERIAL	: 130017
OPERATOR	: LU	TEST	: CLOSE
SHOT NUMBER: 10			
DATE	: 09/30/13	TIME	: 08:00:26
COMPANY	: UIC	MFGR	:
STATION	: LAB	MODEL	: CT 7000 S3
CIRCUIT	:	SERIAL	: 130017
OPERATOR	: LU	TEST	: OPEN
SHOT NUMBER: 9			
DATE	: 09/30/13	TIME	: 07:56:14
COMPANY	: UIC	MFGR	:
STATION	: LAB	MODEL	: CT 7000 S3
CIRCUIT	:	SERIAL	: 130017
OPERATOR	: LU	TEST	: CLOSE
SHOT NUMBER: 8			
DATE	: 09/30/13	TIME	: 07:55:01
COMPANY	: UIC	MFGR	:
STATION	: LAB	MODEL	: CT 7000 S3
CIRCUIT	:	SERIAL	: 130017
OPERATOR	: LU	TEST	: OPEN
SHOT NUMBER: 7			
DATE	: 09/27/13	TIME	: 12:45:28
COMPANY	: UIC	MFGR	:
STATION	: LAB	MODEL	: CT 7000 S3
CIRCUIT	:	SERIAL	: 130017
OPERATOR	: LU	TEST	: CLOSE
SHOT NUMBER: 6			
DATE	: 09/23/13	TIME	: 13:49:33
COMPANY	: UIC	MFGR	:
STATION	: LAB	MODEL	: CT 7000 S3
CIRCUIT	:	SERIAL	: 130017
OPERATOR	: LU	TEST	: CLOSE
SHOT NUMBER: 5			
DATE	: 09/19/13	TIME	: 07:28:04
COMPANY	: UIC	MFGR	:
STATION	: LAB	MODEL	: CT 7000 S3
CIRCUIT	:	SERIAL	: 130017
OPERATOR	: LU	TEST	: OPEN-CLOSE-OPEN

Figure 35. Sample Test Record Directory Printout

3.4.3. Printing a Directory of Test Records Stored in a USB Flash Drive

To print a directory of all test records stored in a USB Flash drive:

- a. Make sure the USB Flash drive is inserted in the unit's USB Flash drive port ("USB MEM" port). Then start from the "START-UP" menu:

```
1. RUN TEST      10/09/13
2. GET RESULTS   10:10:10
3. SAVE/RESTORE
4. SETUP
5. DIAGNOSTICS
```

Press the **[3]** key (*SAVE/RESTORE*).

- b. The following screen will be displayed:

```
1. SAVE SHOT
2. RESTORE SHOT
3. SHOT DIRECTORY
4. ERASE SHOT
5. COPY TO THUMB DRIVE
```

Press the **[3]** key (*SHOT DIRECTORY*).

- c. The following screen will be displayed:

```
1. INTERNAL DIRECTORY
2. THUMB DRIVE DIR
```

Press the **[2]** key (*THUMB DRIVE DIR*).

The directory of test records stored in the USB Flash drive will be printed, and you will be returned to the "START-UP" menu.

3.4.4. Recalling a Test Record from the Flash EEPROM

Follow the steps below to recall a test record from the CT-8000 S3's Flash EEPROM:

- a. Start from the "START-UP" menu:

```
1. RUN TEST      10/09/13
2. GET RESULTS  10:10:10
3. SAVE/RESTORE
4. SETUP
5. DIAGNOSTICS
```

Press the **[3]** key (*SAVE/RESTORE*).

- b. The following screen will be displayed:

```
1. SAVE SHOT
2. RESTORE SHOT
3. SHOT DIRECTORY
4. ERASE SHOT
```

Press the **[2]** key (*RESTORE SHOT*).

- c. The following screen will be displayed:

```
ENTER SHOT NUMBER
  TO BE RESTORED

"ENTER" TO PROCEED
```

Using the keypad, type the record number that you would like to restore. If you do not know the record number, you can first print a test record directory using the instructions in section 3.4.2. Press the **[ENTER]** key.

- d. A confirmation screen will be displayed with some details about the selected test as shown below:

```
RESTORING SHOT #1
TEST: LIVE OPEN
DATE: 09/17/13  10:29

"ENTER" TO PROCEED
```

Press the **[ENTER]** key.

- e. The following screen will be displayed:

```
RESTORE COMPLETE
PRINT RECORD?

1. YES
2. NO
```

1. YES

Press the **[1]** key (YES) if you would like to print the restored test record. The following screen will be displayed:

```
1. PRINT TEST RESULTS
2. PLOT FULL CHART
3. PLOT EXPANSION
4. PLOT 0 - 200MS
```

Please see section 3.3.5, step b, for an explanation of the above printing options.

2. NO

Press the **[2]** key (NO) to restore the test record to the working memory without printing it. Please see section 3.3.5 for instructions on how to view or print the test record details.

3.4.5. Restoring a Test Record from a USB Flash Drive

You can restore a test record from a USB Flash drive to the CT-8000 S3's working memory using the steps below:

- a. Make sure the USB Flash drive containing the test record(s) is inserted in the CT-8000 S3's USB Flash drive port ("USB MEM" port). Then start from the "START-UP" menu:

```
1. RUN TEST      10/09/13
2. GET RESULTS  10:10:10
3. SAVE/RESTORE
4. SETUP
5. DIAGNOSTICS
```

Press the **[3]** key (*SAVE/RESTORE*).

- b. The following screen will be displayed:

```
1. SAVE SHOT
2. RESTORE SHOT
3. SHOT DIRECTORY
4. ERASE SHOT
5. COPY TO THUMB DRIVE
```

Press the **[2]** key (*RESTORE SHOT*).



Option 5 (*COPY TO THUMB DRIVE*) will be displayed only if a USB Flash drive is connected to the unit.

NOTE

- c. The following screen will be displayed:

```
1. INTERNAL STORAGE
2. THUMB DRIVE
```

Press the **[2]** key (*THUMB DRIVE*).

- d. The following screen will be displayed:

```
RESTORE THUMB DRIVE

REC_
```

Type the record number that you would like to restore and press the **[ENTER]** key. If you do not know the record number, you can print a test record directory using the instructions in section 3.4.3.

- e. The following screen will be displayed while the record is being restored:

```
RESTORING RECORD...
```

The following screen will be displayed once the test record has been restored:

```
REC_000 RESTORED!  
PRINT RECORD?  
1. YES  
2. NO
```

1. *YES*

Press the **[1]** key (*YES*) if you would like to print the restored test record. The following screen will be displayed:

```
1. PRINT TEST RESULTS  
2. PLOT FULL CHART  
3. PLOT EXPANSION  
4. PLOT 0 - 200MS
```

Please see section 3.3.5, step b, for an explanation of the above printing options.

2. *NO*

Press the **[2]** key (*NO*) if you do not want to print the restored test record. The test record will be restored to the working memory and can be printed later if desired. You will be returned to the "START-UP" menu.

3.4.6. Copying Test Records to a USB Flash Drive

You can easily copy test records stored in the CT-8000 S3's Flash EEPROM to a connected USB Flash drive using the steps below:

- a. Make sure a USB Flash drive is inserted in the unit's Flash drive port ("USB MEM" port). Then start from the "START-UP" menu:

```
1. RUN TEST      10/09/13
2. GET RESULTS  10:10:10
3. SAVE/RESTORE
4. SETUP
5. DIAGNOSTICS
```

Press the **[3]** key (*SAVE/RESTORE*).

- b. The following screen will be displayed:

```
1. SAVE SHOT
2. RESTORE SHOT
3. SHOT DIRECTORY
4. ERASE SHOT
5. COPY TO THUMB DRIVE
```

Press the **[5]** key (*COPY TO THUMB DRIVE*).

- c. The following screen will be displayed:

```
COPY REC TO THUMB DRV

1. COPY SINGLE RECORD
2. COPY ALL RECORDS
```

1. *COPY SINGLE RECORD*

Press the **[1]** key (*COPY SINGLE RECORD*) if you would like to copy a single record from the CT-8000 S3 to the USB Flash drive. The following screen will be displayed:

```
ENTER RECORD NUMBER
TO COPY TO FLASH DRV

NUMBER:
```

Type the record number that you would like to copy to the USB Flash drive and then press the **[ENTER]** key. If you do not know the record number, you can first print a test record directory using the instructions in section 3.4.2.

Once the test record has been copied to the Flash drive, the following screen will be displayed:

```
REC_001 SAVED TO  
THUMB DRIVE.
```

Press any key to return to the "START-UP" menu.

2. COPY ALL RECORDS

Press the **[2]** key (*COPY ALL RECORDS*) to copy all test records from the unit's Flash EEPROM to the connected USB Flash drive. Once the operation is complete, the following screen will be displayed:

```
ALL RECORDS HAVE BEEN  
TRANSFERRED TO THUMB  
DRIVE!
```

Press any key to return to the "START-UP" menu.

3.4.7. Deleting Test Records from the Flash EEPROM

You can delete one or all test records stored in the CT-8000 S3's Flash EEPROM. To delete test records:

- a. Start from the "START-UP" menu:

```
1. RUN TEST      10/09/13
2. GET RESULTS  10:10:10
3. SAVE/RESTORE
4. SETUP
5. DIAGNOSTICS
```

Press the **[3]** key (*SAVE/RESTORE*).

- b. The following screen will be displayed:

```
1. SAVE SHOT
2. RESTORE SHOT
3. SHOT DIRECTORY
4. ERASE SHOT
```

Press the **[4]** key (*ERASE SHOT*).

- c. The following screen will be displayed:

```
1. ERASE SINGLE SHOT
2. ERASE ALL SHOTS!
```

1. *ERASE SHOT*

Press the **[1]** key (*ERASE SHOT*) if you would like to erase a single shot from the Flash EEPROM. The following screen will be displayed:

```
ENTER SHOT NUMBER
  TO BE ERASED
```

Using the keypad, type the test record number that you would like to erase. If you do not know the record number, you can first print a test record directory using the instructions in section 3.4.2. Press the **[ENTER]** key.

The following confirmation screen will be displayed:

```
ERASE SHOT #1
TEST: OPEN
DATE: 09/17/13  10:29

"ENTER" TO CONFIRM
```

Press **[ENTER]** to erase the test record.

If you do NOT want to erase the test record, press the **[STOP]** key and you will be returned to the "START-UP" menu.

The following screen will be displayed when the test record has been completely erased:

```
ERASE COMPLETE
```

Press any key to return to the "START-UP" menu.

2. ERASE ALL SHOTS!

Press the **[2]** key to erase all test records from the CT-8000 S3's Flash EEPROM. The following screen will be displayed:

```
ALL SHOTS WILL BE
ERASED!

"ENTER" TO CONTINUE
```

Press the **[ENTER]** key to erase all test records.

If you do NOT want to delete all the test records, press the **[STOP]** key and you will be returned to the "START-UP" menu.

- ◆ The following screen will be displayed while the test records are being erased:

```
ERASE IN PROGRESS
PLEASE WAIT...
```

The following screen will be displayed when all the test records have been completely erased:

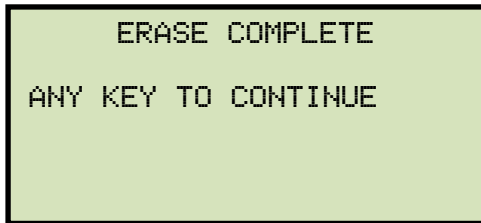

Press any key to return to the "START-UP" menu.

<http://www.51082245.com>

3.4.8. Deleting Test Records from a USB Flash Drive

To erase one or all test records stored on a USB Flash drive:

- a. Make sure a Flash drive is inserted in the unit's Flash drive port ("USB MEM" port). Then start from the "START-UP" menu:

```

1. RUN TEST      10/09/13
2. GET RESULTS  10:10:10
3. SAVE/RESTORE
4. SETUP
5. DIAGNOSTICS
  
```

Press the **[3]** key (*SAVE/RESTORE*).

- b. The following screen will be displayed:

```

1. SAVE SHOT
2. RESTORE SHOT
3. SHOT DIRECTORY
4. ERASE SHOT
5. COPY TO THUMB DRIVE
  
```

Press the **[4]** key (*ERASE SHOT*).

- c. The following screen will be displayed:

```

1. ERASE INTERNAL REC
2. ERASE THUMB DRV REC
  
```

Press the **[2]** key (*ERASE THUMB DRV REC*).

- d. The following screen will be displayed:

```

          ERASE RECORD

1. ERASE SINGLE REC.
2. ERASE ALL RECORDS

"STOP" TO EXIT
  
```

1. *ERASE SINGLE REC*

Press the **[1]** key (*ERASE SINGLE REC*) if you would like to erase a single record from the USB Flash drive. The following screen will be displayed:

```
ERASE THUMB DRIVE
REC_
```

Type the record number to be deleted and press the **[ENTER]** key. If you do not know the record number, you can first print a test record directory using the instructions in section 3.4.3. The selected test record will be deleted and the following screen will be displayed:

```
THUMB DRIVE REC_000
ERASED!
```

Press any key to continue. The screen shown at the beginning of step d will be displayed again allowing you to delete additional records if desired. Press the **[STOP]** key to return to the "START-UP" menu.

2. ERASE ALL RECORDS

Press the **[2]** key (*ERASE ALL RECORDS*) if you would like to erase all the test records stored in the USB Flash drive. The following screen will be displayed:

```
ERASE ALL THUMB DRIVE
RECORDS?

ARE YOU SURE?

"ENTER" TO CONTINUE.
```

If you would like to abort the erase operation, press the **[STOP]** key. No records will be erased from the USB Flash drive, and you will be returned to the "START-UP" menu.

Press the **[ENTER]** key to continue with the erase operation. The following screen will be displayed when all records have been deleted from the USB Flash drive:

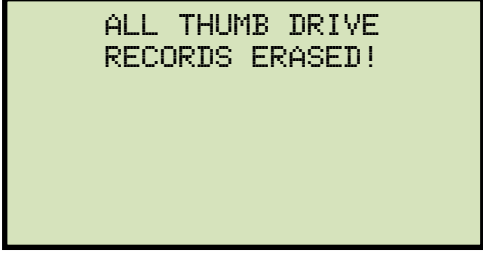

ALL THUMB DRIVE
RECORDS ERASED!

Press any key to return to the "START-UP" menu.

<http://www.51082245.com>

3.5 Working With Test Plans

The CT-8000 S3 comes with the Vanguard Circuit Breaker Analysis S2 (VCBA S2) PC Software that can be used to create circuit breaker test plans. The test plans can then be transferred to the CT-8000 S3. The CT-8000 S3 can store up to 99 circuit breaker test plans in its Flash EEPROM.

A circuit breaker test plan contains breaker maximum/minimum parameters and can be used to quickly test a breaker. A typical list of operating parameters in a test plan includes the following:

- Max/Min Contact/Resistor Trip Time
- Max/Min Contact/Resistor CLOSE time
- Max Contact Spread Time
- Max Resistor Contact Spread Time
- Max/Min Contact CLOSE-OPEN Time
- Max/Min Contact OPEN-CLOSE Time
- Max/Min Resistor CLOSE-OPEN Time
- Max/Min Resistor OPEN-CLOSE Time
- Max/Min Breaker Stroke
- Max/Min Breaker Trip Velocity
- Max/Min Breaker CLOSE Velocity
- Max/Min Breaker Over-Travel
- Max/Min Breaker Bounce-Back
- Trip Velocity Analysis Calculation Points
- CLOSE Velocity Analysis Calculation Points

If a timing test is executed with a breaker test plan, the timing report will display a Pass/Fail indicator for each of the parameters tested. The Pass/Fail status is determined by comparing the values in the test plan to the timing test results.

3.5.1. Recalling a Breaker Test Plan for Use

Use the steps below to recall a breaker test plan to use for a timing test:

- a. Start from the "START-UP" menu:

```
1. RUN TEST      10/09/13
2. GET RESULTS   10:10:10
3. SAVE/RESTORE
4. SETUP
5. DIAGNOSTICS
```

Press the **[4]** key (*SETUP*).

- b. The following screen will be displayed:

```

1. ANALYSIS POINTS
2. MEASUREMENT UNITS
3. SHOT DESCRIPTION
4. NUMBER OF CHANNELS
5. NEXT PAGE

```

Press the **[1]** key (*ANALYSIS POINTS*).

- c. The following screen will be displayed:

```

1. OPEN TIMING
2. CLOSE TIMING
3. PRINT SETTINGS
4. TEST PLANS

```

Press the **[4]** key (*TEST PLANS*).

- d. The following screen will be displayed:

```

1. LOAD TEST PLAN
2. PRINT TEST PLAN
3. PRINT PLAN DIR
4. ERASE TEST PLAN
5. SAVE TEST PLAN

```

Press the **[1]** key (*LOAD TEST PLAN*).

- e. The first test plan stored in the CT-8000 S3's Flash EEPROM will be listed:

```

TEST PLAN # 01
B20-145-20-7
SIEMENS
DEMO TEST PLAN 1

```

You can scroll through the list of test plans by pressing the **[▲]** and **[▼]** keys. Once you have located the test plan that you would like to load, press the **[ENTER]** key. The test plan will be loaded and you will be returned to the "START-UP" menu. The test plan will be used for all subsequent timing tests. A typical test results printout with Pass/Fail indicators is shown in Figure 36.



The following screen will be displayed if there are no test plans stored in the CT-8000 S3's Flash EEPROM:

NOTE

NO TEST PLANS FOUND

"ENTER" TO CONTINUE

Press the **[ENTER]** key to return to the "START-UP" menu.

BREAKER TIMING RESULTS - 60 Hz					
SHOT NUMBER: 0006					
DATE: 09/01/03 TIME: 13:17:17					
COMPANY: VANGUARD INSTRUMENT					
STATION:					
CIRCUIT:					
MFR: ITE					
MODEL: 14 4K					
S/N:					
OPERATOR:					
TEST: OPEN					
CONTACT TIME					
CH	TIME	CYCLE	P/F	BOUNCE	WIPE
	<ms>			<ms>	<in>
1	034.20	02.05	PASS	000.20	00.72
2	034.40	02.06	PASS	000.10	00.73
3	031.10	01.87	PASS	000.20	00.52
DELTA TIME <ms>: 003.30 PASS					
TRAVEL ANALYSIS T1 P/F					
STROKE	in	07.01	PASS		
SPEED	ft/s	08.53	FAIL		
OVER-TRAVEL	in	00.02	PASS		
BOUNCE BACK	in	00.05	PASS		
SPEED ANALYSIS:					
POINT 1 = 01.00 in					
POINT 2 = 05.00 in					
V1 NOMINAL VOLTAGE = 47 VOLTS					
V1 MINIMUM VOLTAGE = 47 VOLTS					
INITIATOR CURRENT = 05.7 AMPS					
SHOT LENGTH: 1 SECOND					
INSERTION RESISTOR: NO					
TRIGGER: INTERNAL					

Pass/Fail Indicators

Figure 36. Typical Test Results Printout with Pass/Fail Indicators

3.5.2. Printing a Directory of Test Plans Stored in the CT-8000 S3's Memory

You can print a directory of all the test plans stored in the CT-8000 S3's Flash EEPROM using the steps below:

- a. Start from the "START-UP" menu:

```
1. RUN TEST      10/09/13
2. GET RESULTS   10:10:10
3. SAVE/RESTORE
4. SETUP
5. DIAGNOSTICS
```

Press the **[4]** key (*SETUP*).

- b. The following screen will be displayed:

```
1. ANALYSIS POINTS
2. MEASUREMENT UNITS
3. SHOT DESCRIPTION
4. NUMBER OF CHANNELS
5. NEXT PAGE
```

Press the **[1]** key (*ANALYSIS POINTS*).

- c. The following screen will be displayed:

```
1. OPEN TIMING
2. CLOSE TIMING
3. PRINT SETTINGS
4. TEST PLANS
```

Press the **[4]** key (*TEST PLANS*).

- d. The following screen will be displayed:

```
1. LOAD TEST PLAN
2. PRINT TEST PLAN
3. PRINT PLAN DIR
4. ERASE TEST PLAN
5. SAVE TEST PLAN
```

Press the **[3]** key (*PRINT PLAN DIR*). The test plan directory will be printed on the built-in thermal printer and you will be returned to the "START-UP" menu. A sample test plan directory is shown in Figure 37.

TEST PLAN DIRECTORY	
TEST PLAN #:	1
BRKR TYPE:	SPS2 121
BRKR MFR:	Siemens
COMMENTS:	
TEST PLAN #:	2
BRKR TYPE:	121/145PM HBM Hydraul
BRKR MFR:	ABB121/145pm
COMMENTS:	
TEST PLAN #:	3
BRKR TYPE:	CGH-50
BRKR MFR:	McGRAW-EDISON
COMMENTS:	

Figure 37. Typical Test Plan Directory Printout

3.5.3. Printing a Directory of Test Plans Stored in a USB Flash Drive

Follow the steps below to print a directory of all test plans stored in a USB Flash drive:

- a. Make sure a USB Flash drive is inserted in the unit's USB Flash drive port ("USB MEM" port), and then start from the "START-UP" menu:

```
1. RUN TEST      10/09/13
2. GET RESULTS   15:10:10
3. SAVE/RESTORE
4. SETUP
5. DIAGNOSTICS
```

Press the **[4]** key (*SETUP*).

- b. The following screen will be displayed:

```
1. ANALYSIS POINTS
2. MEASUREMENT UNITS
3. SHOT DESCRIPTION
4. NUMBER OF CHANNELS
5. NEXT PAGE
```

Press the **[1]** key (*ANALYSIS POINTS*).

- c. The following screen will be displayed:

```
1. OPEN TIMING
2. CLOSE TIMING
3. PRINT SETTINGS
4. TEST PLANS
```

Press the **[4]** key (*TEST PLANS*).

- d. The following screen will be displayed:

```
1. LOAD TEST PLAN
2. PRINT TEST PLAN
3. PRINT PLAN DIR
4. ERASE TEST PLAN
5. SAVE TEST PLAN
```

Press the **[3]** key (*PRINT PLAN DIR*).

- e. The following screen will be displayed:

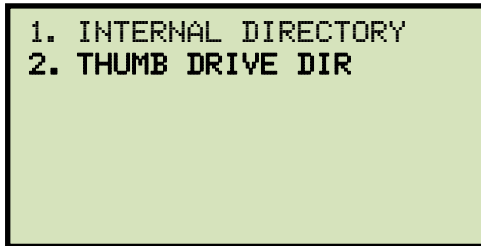

Press the **[2]** key (*THUMB DRIVE DIR*). The directory of test plans stored on the USB Flash drive will be printed on the built-in thermal printer and you will be returned to the "START-UP" menu.

<http://www.51082245.com>

3.5.4. Printing a Breaker Test Plan Stored in the CT-8000's Memory

Follow the steps below to print a breaker test plan stored in the CT-8000 S3's Flash EEPROM:

- a. Start from the "START-UP" menu:

```
1. RUN TEST      10/09/13
2. GET RESULTS  10:10:10
3. SAVE/RESTORE
4. SETUP
5. DIAGNOSTICS
```

Press the **[4]** key (*SETUP*).

- b. The following screen will be displayed:

```
1. ANALYSIS POINTS
2. MEASUREMENT UNITS
3. SHOT DESCRIPTION
4. NUMBER OF CHANNELS
5. NEXT PAGE
```

Press the **[1]** key (*ANALYSIS POINTS*).

- c. The following screen will be displayed:

```
1. OPEN TIMING
2. CLOSE TIMING
3. PRINT SETTINGS
4. TEST PLANS
```

Press the **[4]** key (*TEST PLANS*).

- d. The following screen will be displayed:

```
1. LOAD TEST PLAN
2. PRINT TEST PLAN
3. PRINT PLAN DIR
4. ERASE TEST PLAN
5. SAVE TEST PLAN
```

Press the **[2]** key (*PRINT TEST PLAN*).

- e. The first test plan stored in the CT-8000 S3's Flash EEPROM will be listed:

```
TEST PLAN # 01  
B20-145-20-7  
SIEMENS  
DEMO TEST PLAN 1
```

You can scroll through the list of test plans by pressing the **[▲]** and **[▼]** keys. Once you have located the test plan that you would like to print, press the **[ENTER]** key. The test plan will be printed on the built-in thermal printer and you will be returned to the "START-UP" menu. A sample breaker test plan printout is shown in Figure 38.

3.5.5. Printing a Breaker Test Plan Stored in a USB Flash Drive

Follow the steps below to print a breaker test plan stored in a USB Flash drive:

- a. Make sure a USB Flash drive is connected to the unit's USB Flash drive port ("USB MEM" port), and then start from the "START-UP" menu:

```
1. RUN TEST      10/09/13
2. GET RESULTS   15:30:20
3. SAVE/RESTORE
4. SETUP
5. DIAGNOSTICS
```

Press the **[4]** key (*SETUP*).

- b. The following screen will be displayed:

```
1. ANALYSIS POINTS
2. MEASUREMENT UNITS
3. SHOT DESCRIPTION
4. NUMBER OF CHANNELS
5. NEXT PAGE
```

Press the **[1]** key (*ANALYSIS POINTS*).

- c. The following screen will be displayed:

```
1. OPEN TIMING
2. CLOSE TIMING
3. PRINT SETTINGS
4. TEST PLANS
```

Press the **[4]** key (*TEST PLANS*).

- d. The following screen will be displayed:

```
1. LOAD TEST PLAN
2. PRINT TEST PLAN
3. PRINT PLAN DIR
4. ERASE TEST PLAN
5. SAVE TEST PLAN
```

Press the **[2]** key (*PRINT TEST PLAN*).

- e. The following screen will be displayed:

```
1. PRINT INTERNAL TP
2. PRINT FLASH DRV TP
```

Press the **[2]** key (*PRINT FLASH DRV TP*).

- f. The following screen will be displayed:

```
PRINT THUMB DRIVE TP
PLAN_
```

Type the test plan number to be deleted and press the **[ENTER]** key. If you do not know the test plan number, you can first print a test plan directory using the instructions in section 3.5.3. The test plan details will be printed on the built-in thermal printer, and you will be returned to the "START-UP" menu.

3.5.6. Copying a Test Plan to a USB Flash drive

Follow the steps below to copy a test plan from the unit's internal memory to a connected USB Flash drive:

- a. Make sure a USB Flash drive is inserted in the unit's USB Flash drive port ("USB MEM" port), and then start from the "START-UP" menu:

```
1. RUN TEST      10/09/13
2. GET RESULTS   10:10:10
3. SAVE/RESTORE
4. SETUP
5. DIAGNOSTICS
```

Press the **[4]** key (*SETUP*).

- b. The following screen will be displayed:

```
1. ANALYSIS POINTS
2. MEASUREMENT UNITS
3. SHOT DESCRIPTION
4. NUMBER OF CHANNELS
5. NEXT PAGE
```

Press the **[1]** key (*ANALYSIS POINTS*).

- c. The following screen will be displayed:

```
1. OPEN TIMING
2. CLOSE TIMING
3. PRINT SETTINGS
4. TEST PLANS
```

Press the **[4]** key (*TEST PLANS*).

- d. The following screen will be displayed:

```
1. LOAD TEST PLAN
2. PRINT TEST PLAN
3. PRINT PLAN DIR
4. ERASE TEST PLAN
5. SAVE TEST PLAN
6. COPY TO THUMB DRIVE
```

Press the **[6]** key (*COPY TO THUMB DRIVE*).

- e. The following screen will be displayed:

```
ENTER TP NUMBER  
TO COPY TO FLASH DRV  
TP NUMBER:
```

Type the test plan number to copy using the keypad and then press the **[ENTER]** key. If you do not know the test plan number, you can first print a test plan directory using the instructions in section 3.5.2. The selected test plan will be copied to the USB Flash drive and the following screen will be displayed:

```
TP 1      SAVED TO THUMB  
DRIVE AS PLAN_001
```

Press any key to return to the "START-UP" menu.

TEST PLAN NUMBER 1				
MFR:	SPS2 121			
TYPE:	Siemens			
COMMENT:				
CONTACT TIME PARAMETERS				
		OPEN	CLOSE	
MAX V		026.0	063.0	
MIN V		020.0	047.0	
DELTA LIM V		004.0	004.0	
C-O, O-C PARAMS: LIVE DEAD				
MAX V		040.0	200.0	
MIN V		020.0	150.0	
RESISTOR ON-TIME PARAMETERS				
		OPEN	CLOSE	
MAX V		000.0	000.0	
MIN V		000.0	000.0	
DELTA LIM V		000.0	000.0	
C-O, O-C PARAMS: LIVE DEAD				
MAX V		000.0	000.0	
MIN V		000.0	000.0	
TRAVEL PARAMETERS				
	STRK	VEL	O-TUL	BNC-BK
	mm	M/S	mm	mm
OPEN HI	085.1	04.90	003.0	003.0
OPEN LOW	074.9	04.20	000.0	000.0
CLOSE HI	085.1	04.50	004.1	004.1
CLOSE LO	074.9	03.50	000.0	000.0
VEL = C*(DIST$AP1 - AP2$)/STROKE]				
C = 12.00 M/S				
OPEN SPEED ANALYSIS POINTS:				
POINT 1 = CONTACT				
POINT 2 = CONTACT PLUS 010.0 ms				
CLOSE SPEED ANALYSIS POINTS:				
POINT 1 = CONTACT				
POINT 2 = CONTACT MINUS 010.0 ms				

Velocity Calculation Formula

Figure 38. Typical Breaker Test Plan Printout

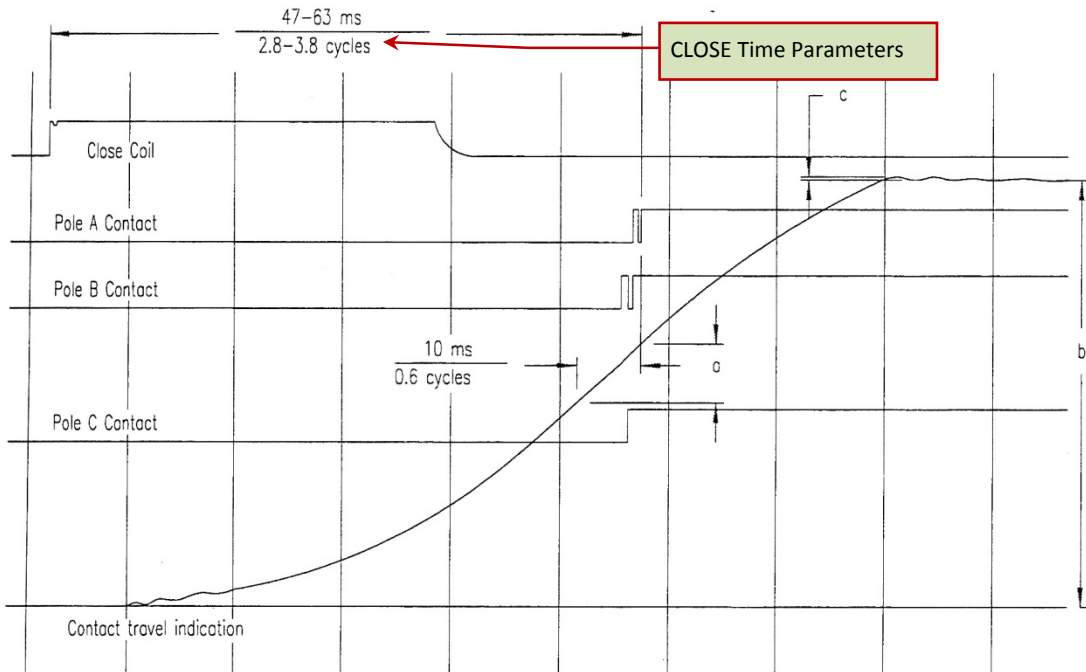

Example of Close Operation Record

Calculation For Contact Closing Velocity

$$V = 12.0a/b \text{ meters/second}$$

Calculation For Overtravel/rebound

$$S = 120.0c/b \text{ millimeters}$$

Note: a,b and c may be measured in any consistent units

Contact Stroke = 120 mm
 Transducer Stroke = 80 mm

Velocity
 Calculation
 Formula

Figure 39. Siemens SPS2 121 CLOSE Timing Illustration

<http://www...>

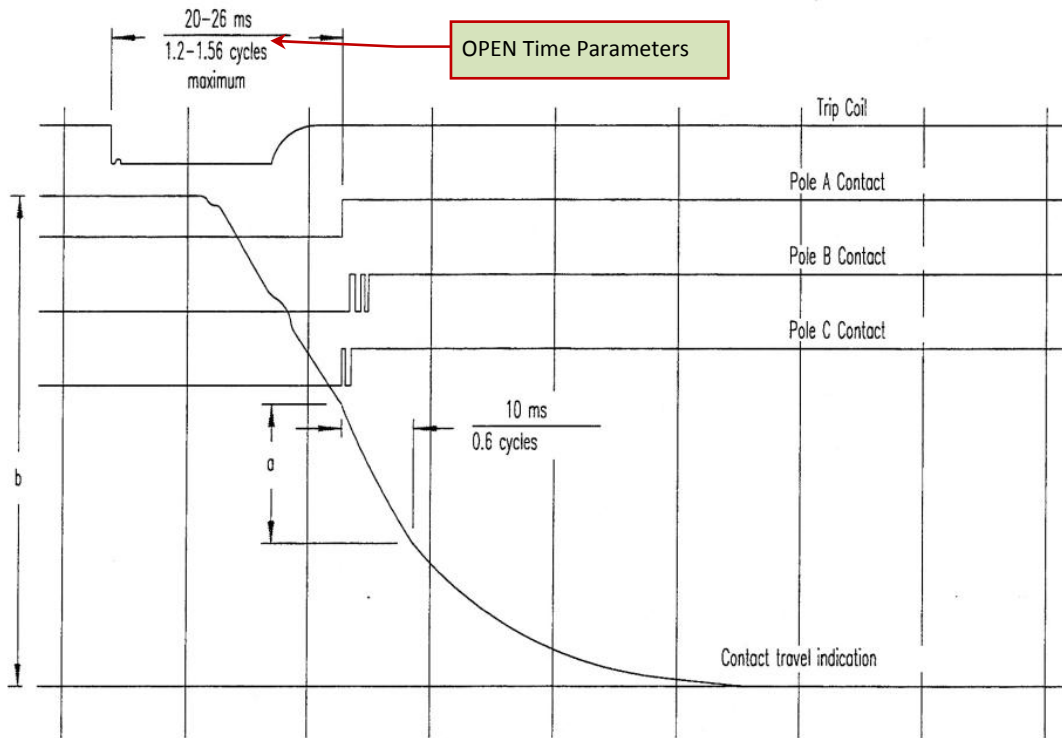

Example of Opening Operation Record

Calculation For Contact Opening Velocity

$$V=12.0a/b \text{ meter/second}$$

Note: a,b and may be measured in any consistant units

Contact Stroke = 120mm
 Transducer Stroke = 80 mm

Figure 40. Siemens SPS2 121 OPEN Timing Illustration

4.0 DIAGNOSTICS, VERIFICATION, AND TROUBLESHOOTING

4.1 Performing a Slow-Close Test

The CT-8000 S3 offers a unique “Slow-Close” test feature. This test measures the distance a breaker’s contact travels from the fully opened position to the point of contact or “touch” position, and the contact wipe or penetration distance. The test requires the operator to manually jack the breaker’s contact from the fully open position to the fully closed position.

Contact channels 1, 2, and 3 and transducer channel 1 are used for “Slow-Close” testing. The CT-8000 S3 measures the contact touch and contact wipe for each contact channel. Contact touch is the distance measured from the contact being fully open to the first position where the contact channel is electrically closed. Contact wipe, or penetration, is the distance measured from the contact’s first electrically closed position to the final closed, latching position.

Follow the steps below to perform a “Slow-Close” test:



The Slow-Close test does not support resistor type transducers.

NOTE

- a. Start from the “START-UP” menu:

```
1. RUN TEST      10/10/13
2. GET RESULTS  10:10:10
3. SAVE/RESTORE
4. SETUP
5. DIAGNOSTICS
```

Press the **[5]** key (*DIAGNOSTICS*).

- b. The following screen will be displayed:

```
1. SLOW CLOSE TEST
2. CHECK HOOKUP
3. TEST TRANSDUCER
4. PRINT DATA
5. ENCODER FILTER
6. CONTACT FILTER
```

Press the **[1]** key (*SLOW CLOSE TEST*).

- c. The following screen will be displayed:

```
BRKR SLOW CLOSE TEST
RMV CB GND (1 SIDE)

"ENTER" TO BEGIN
```

Press the **[ENTER]** key to begin the test.

- d. The following screen will be displayed:

```
CONTACT 1: OPEN
CONTACT 2: OPEN
CONTACT 3: OPEN

LIFT TO CLS BRKR NOW
```

Manually start closing the breaker and then press the "ENTER" key. The test results will be printed and you will be returned to the "START-UP" menu. A typical test results printout is shown in Figure 41.

BREAKER TIMING RESULTS - 50 Hz		
SHOT NUMBER: 0006		
DATE: 12/28/00 TIME: 07:41:30		
COMPANY:		
STATION:		
CIRCUIT:		
MFR:		
MODEL:		
S/N:		
OPERATOR:		
TEST: SLOW CLOSE		
	CT TOUCH	CT WIPE
CH 1	08.23 in	00.86 in
CH 2	08.41 in	00.68 in
CH 3	08.40 in	00.69 in

Figure 41. Typical Slow-Close Test Results Printout



NOTE

The breaker's stroke is the sum of the contact touch and contact wipe distances.

4.2 Performing a Transducer Self-Test

You can check the transducer electronics by connecting the transducer to the CT-8000 S3 and running a transducer self-test using the instructions below:

- a. Start from the "START-UP" menu:

```
1. RUN TEST      10/10/13
2. GET RESULTS  10:10:10
3. SAVE/RESTORE
4. SETUP
5. DIAGNOSTICS
```

Press the **[5]** key (*DIAGNOSTICS*).

- b. The following screen will be displayed:

```
1. SLOW CLOSE TEST
2. CHECK HOOKUP
3. TEST TRANSDUCER
4. PRINT DATA
5. ENCODER FILTER
6. CONTACT FILTER
```

Press the **[3]** key (*TEST TRANSDUCER*).

- c. The following screen will be displayed:

```
TRANSDUCER TEST:
T1= 0.00 IN / 000.0°
T2= 0.00 IN / 000.0°
T3= 0.00 IN / 000.0°
R1= 0.00 IN
R2= 0.00 IN
R3= 0.00 IN
```



NOTE

- T1 - T3 refer to digital transducers. R1 - R3 refer to resistor type transducers.
- If a resistor type transducer is connected, Resistor Setup #1 will be used (see section 3.2.11). If a resistor transducer setup is not defined, a default value of 10 inches is used as the full transducer travel distance.

Move the transducer slider to a known distance and observe the display.

- d. The screen will be updated with the new transducer position information:

```
TRANSDUCER TEST:  
T1= 5.00 IN / 360.0°  
T2= 0.00 IN / 000.0°  
T3= 0.00 IN / 000.0°  
R1= 0.00 IN  
R2= 0.00 IN  
R3= 0.00 IN
```

If the transducer was moved 5 inches, the screen should display 5.00 IN. You can continue to move the transducer slider and observe the screen values to make sure they are correct. Press the **[STOP]** key to end the test and return to the "START-UP" menu.

4.3 Testing the Cable Hookups

You can check the CT-8000 S3 contact cable connections to the circuit breaker using the steps below:

- a. Start from the "START-UP" menu:

```

1. RUN TEST      10/10/13
2. GET RESULTS  10:10:10
3. SAVE/RESTORE
4. SETUP
5. DIAGNOSTICS

```

Press the **[5]** key (*DIAGNOSTICS*).

- b. The following screen will be displayed:

```

1. SLOW CLOSE TEST
2. CHECK HOOKUP
3. TEST TRANSDUCER
4. PRINT DATA
5. ENCODER FILTER
6. CONTACT FILTER

```

Press the **[2]** key (*CHECK HOOKUP*).

- c. The following screen will be displayed:

```

MAKE SURE BREAKER IS
  IN CLOSED POSITION

THEN PRESS "START"

```

Make sure the breaker is in the CLOSED position and then press the **[START]** key.

- d. The screen will be updated to show the status of each contact as shown:

```

  1   2   3
  C   -   -

"START" TO RETEST
"STOP" TO EXIT

```

A report will also be printed on the thermal printer showing the status of each contact. A contact closure is shown as "C" on the screen and on the printout. An open contact is shown as "-" on the screen and on the printout.

Press the **[START]** key to retest the cable connections, or press the **[STOP]** key to end the test and return to the "START-UP" menu.

<http://www.51082245.com>

4.4 Printing Raw Test Record Data

You can print the raw hexadecimal timing data collected by the CT-8000 S3 using the "PRINT DATA" command. This feature is used mainly for factory diagnostic testing.

The CT-8000 S3 collects 20,000 data points in the one-second timing window. As a result, each data sample is 0.05 ms apart. By looking at the time marker and the data point, you can find the channel activities vs. time in the timing record.

To print the CT-8000 S3 timing data from memory:

- a. Start from the "START-UP" menu:

```
1. RUN TEST      10/10/13
2. GET RESULTS   10:10:10
3. SAVE/RESTORE
4. SETUP
5. DIAGNOSTICS
```

Press the **[5]** key (*DIAGNOSTICS*).

- b. The following screen will be displayed:

```
1. SLOW CLOSE TEST
2. CHECK HOOKUP
3. TEST TRANSDUCER
4. PRINT DATA
5. ENCODER FILTER
6. CONTACT FILTER
```

Press the **[4]** key (*PRINT DATA*).

- c. The following screen will be displayed:

```
STARTING ADDRESS?:
```

Enter the starting address boundary by typing a number from 0 to 9. Pressing the **[0]** key will start printing the data at address location 0, or the first data point. Pressing the **[1]** key will start printing the data at address location .10000 second.

d. The following screen will be displayed:

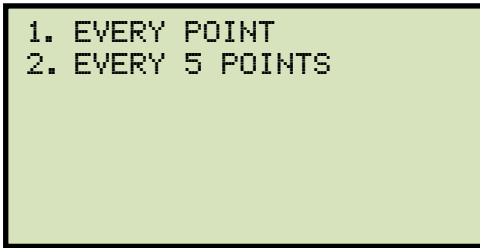

Press the **[1]** key to print every data point. The data points will be printed and you will be returned to the “START-UP” menu.

Press the **[2]** key to print every 5 data points. The data points will be printed and you will be returned to the “START-UP” menu.

A partial data points printout is shown in Figure 42.

 Due to the large number of data points, even selecting the “Every 5 Points” option will produce a VERY long report printout!

WARNING

TIME	1	2	3	4	5	6	U1	U2	U3	I	EXI	CT	CT	CT	TRU1	TRU2	TRU3
S												1	2	3			
.00000	FF	FF	FF	00	00	00	00	00	00	80	7F	01	00	00	8000	8000	8000
.00025	FF	FF	FF	00	00	00	00	00	00	80	7F	01	00	00	8000	8000	8000
.00050	FF	FF	FF	00	00	00	00	00	00	80	7F	01	00	00	8000	8000	8000
.00075	FF	FF	FF	00	00	00	00	00	00	7F	7F	01	00	00	8000	8000	8000
.00100	FF	FF	FF	00	00	00	00	00	00	7E	80	01	00	00	8000	8000	8000
.00125	FF	FF	FF	00	00	00	00	00	00	7C	7F	01	00	00	8000	8000	8000
.00150	FF	FF	FF	00	00	00	00	00	00	7A	80	01	00	00	8000	8000	8000
.00175	FF	FF	FF	00	00	00	00	00	00	78	7F	01	00	00	8000	8000	8000
.00200	FF	FF	FF	00	00	00	00	00	00	76	7F	01	00	00	8000	8000	8000
.00225	FF	FF	FF	00	00	00	00	00	00	73	7F	01	00	00	8000	8000	8000
.00250	FF	FF	FF	00	00	00	00	00	00	71	80	01	00	00	8000	8000	8000
.00275	FF	FF	FF	00	00	00	00	00	00	6E	7F	01	00	00	8000	8000	8000
.00300	FF	FF	FF	00	00	00	00	00	00	6C	80	01	00	00	8000	8000	8000
.00325	FF	FF	FF	00	00	00	00	00	00	6A	7F	01	00	00	8000	8000	8000
.00350	FF	FF	FF	00	00	00	00	00	00	68	80	01	00	00	8000	8000	8000
.00375	FF	FF	FF	00	00	00	00	00	00	67	7F	01	00	00	8000	8000	8000
.00400	FF	FF	FF	00	00	00	00	00	00	66	7F	01	00	00	8000	8000	8000
.00425	FF	FF	FF	00	00	00	00	00	00	65	7F	01	00	00	8000	8000	8000
.00450	FF	FF	FF	00	00	00	00	00	00	64	7F	01	00	00	8000	8000	8000
.00475	FF	FF	FF	00	00	00	00	00	00	63	7F	01	00	00	8000	8000	8000
.00500	FF	FF	FF	00	00	00	00	00	00	63	7F	01	00	00	8000	8000	8000
.00525	FF	FF	FF	00	00	00	00	00	00	62	7F	01	00	00	8000	8000	8000
.00550	FF	FF	FF	00	00	00	00	00	00	62	7F	01	00	00	8000	8000	8000
.00575	FF	FF	FF	00	00	00	00	00	00	61	7F	01	00	00	8000	8000	8000
.00600	FF	FF	FF	00	00	00	00	00	00	61	7F	01	00	00	8000	8000	8000
.00625	FF	FF	FF	00	00	00	00	00	00	61	7F	01	00	00	8000	8000	8000
.00650	FF	FF	FF	00	00	00	00	00	00	61	7F	01	00	00	8000	8000	8000
.00675	FF	FF	FF	00	00	00	00	00	00	60	7F	01	00	00	8000	8000	8000
.00700	FF	FF	FF	00	00	00	00	00	00	60	7F	01	00	00	8000	8000	8000
.00725	FF	FF	FF	00	00	00	00	00	00	60	7F	01	00	00	8000	8000	8000
.00750	FF	FF	FF	00	00	00	00	00	00	5F	7F	01	00	00	8000	8000	8000
.00775	FF	FF	FF	00	00	00	00	00	00	5F	7F	01	00	00	8000	8000	8000
.00800	FF	FF	FF	00	00	00	00	00	00	5F	7F	01	00	00	8000	8000	8000
.00825	FF	FF	FF	00	00	00	00	00	00	5F	7F	01	00	00	8000	8000	8000
.00850	FF	FF	FF	00	00	00	00	00	00	5F	7F	01	00	00	8000	8000	8000
.00875	FF	FF	FF	00	00	00	00	00	00	5F	7F	01	00	00	8000	8000	8000
.00900	FF	FF	FF	00	00	00	00	00	00	5F	7F	01	00	00	8000	8000	8000
.00925	FF	FF	FF	00	00	00	00	00	00	5F	7F	01	00	00	8000	8000	8000
.00950	FF	FF	FF	00	00	00	00	00	00	60	7F	01	00	00	8000	8000	8000
.00975	FF	FF	FF	00	00	00	00	00	00	60	7F	01	00	00	8000	8000	8000
.01000	FF	FF	FF	00	00	00	00	00	00	60	7F	01	00	00	8000	8000	8000
.01025	FF	FF	FF	00	00	00	00	00	00	61	7F	01	00	00	8000	8000	8000
.01050	FF	FF	FF	00	00	00	00	00	00	61	7F	01	00	00	8000	8000	8000
.01075	FF	FF	FF	00	00	00	00	00	00	62	7F	01	00	00	8000	8000	8000
.01100	FF	FF	FF	00	00	00	00	00	00	62	7F	01	00	00	8000	8000	8000
.01125	FF	FF	FF	00	00	00	00	00	00	63	7F	01	00	00	8000	8000	8000
.01150	FF	FF	FF	00	00	00	00	00	00	63	7F	01	00	00	8000	8000	8000
.01175	FF	FF	FF	00	00	00	00	00	00	64	7F	01	00	00	8000	8000	8000
.01200	FF	FF	FF	00	00	00	00	00	00	64	7F	01	00	00	8000	8000	8000
.01225	FF	FF	FF	00	00	00	00	00	00	64	7F	01	00	00	8000	8000	8000
.01250	FF	FF	FF	00	00	00	00	00	00	64	7F	01	00	00	8000	8000	8000
.01275	FF	FF	FF	00	00	00	00	00	00	64	7F	01	00	00	8000	8000	8000
.01300	FF	FF	FF	00	00	00	00	00	00	64	7F	01	00	00	8000	8000	8000
.01325	FF	FF	FF	00	00	00	00	00	00	64	7F	01	00	00	8000	8000	8000
.01350	FF	FF	FF	00	00	00	00	00	00	63	7F	01	00	00	8000	8000	8000
.01375	FF	FF	FF	00	00	00	00	00	00	63	7F	01	00	00	8000	8000	8000
.01400	FF	FF	FF	00	00	00	00	00	00	62	7F	01	00	00	8000	8000	8000
.01425	FF	FF	FF	00	00	00	00	00	00	61	7F	01	00	00	8000	8000	8000
.01450	FF	FF	FF	00	00	00	00	00	00	61	7F	01	00	00	8000	8000	8000
.01475	FF	FF	FF	00	00	00	00	00	00	5E	7F	01	00	00	8000	8000	8000
.01500	FF	FF	FF	00	00	00	00	00	00	5D	7F	01	00	00	8000	8000	8000
.01525	FF	FF	FF	00	00	00	00	00	00	5C	7F	01	00	00	8000	8000	8000
.01550	FF	FF	FF	00	00	00	00	00	00	5A	7F	01	00	00	8000	8000	8000
.01575	FF	FF	FF	00	00	00	00	00	00	5A	7F	01	00	00	8000	8000	8000

Figure 42. Partial Data Points Printout

4.5 Troubleshooting Guide

PROBLEM DESCRIPTION	Suggested Solution
<p>CT-8000 S3 will neither trip nor close the breaker.</p>	<ul style="list-style-type: none"> • Make sure you hold down the [ARM] switch during each test. • Check the OPEN or CLOSE fuses. • Check the initiate leads. <ul style="list-style-type: none"> ○ For a “Positive Trip” circuit, one CLOSE lead and one OPEN lead should be connected to the positive side of the power supply. ○ For a “Negative Trip” circuit, one CLOSE lead and one OPEN lead should be connected to the negative side of the power supply.
<p>Getting following message when using external trigger:</p> 	<ul style="list-style-type: none"> • Trigger voltage was not detected by the CT-8000 S3. • Check the external trigger input to the CT-8000 S3. • Make sure the external trigger signal is present when the CT-8000 S3 displays the “AWAITING TRIGGER” message on the screen.
<p>Missing timing or transducer channels on report and graphic output.</p>	<ul style="list-style-type: none"> • Timing or transducer channels were not turned on. See section 3.2.7 for instructions on how to turn on the contact and transducer channels.
<p>No contact time (0 ms) in Trip or CLOSE test.</p>	<ul style="list-style-type: none"> • Make sure only one side of the breaker is grounded. • Make sure the breaker operates on the OPEN or CLOSE test only. A dual operation OPEN-CLOSE or CLOSE-OPEN will result in a 0ms reading. • The CT-8000 S3 contact channels may be damaged or the cables may be bad. Try the “Check Hook-UP” test (see section 4.3).
<p>No contact time (0 ms) in CLOSE-OPEN test.</p>	<ul style="list-style-type: none"> • Make sure the breaker contacts complete the transition from the OPEN (initial state) to the CLOSE state, then to the OPEN (final state). You can see the transition by looking at the timing chart. • Make sure the contact CLOSE state is longer than 10ms. The CT-8000 S3 has a 10ms de-bounce time so any contact state less than or equal to 10ms is invalid. • Try the CLOSE-OPEN test using contact channel #1.

When performing an OPEN-CLOSE test, the breaker opens but will not close.

- Delay between OPEN to CLOSE is probably too short. Increase the delay time.

No data or erratic reading on travel transducer.

- Bad transducer. Perform a transducer diagnostic test using the instructions in section 4.2.
- Transducer slider is not secured to timing rod.
- Transducer is not secured properly.

No activity on "V2" or "V3" voltage input channel.

- The "V2" and "V3" voltage sensing input channels require a voltage change greater than 30V.

How do I turn on automatic printing of test reports?

- Please see section 3.2.3.

5.0 APPENDICES

5.1 APPENDIX A – ITE Model 14.4K Circuit Breaker Timing Charts and Reports

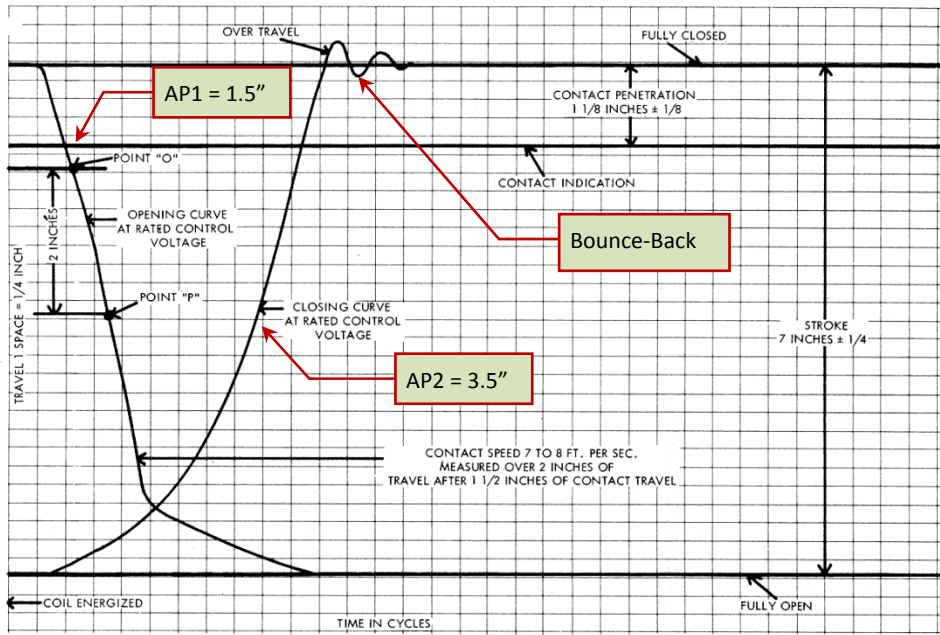

TYPICAL NO LOAD TRAVEL CURVES FOR OPENING AND CLOSING OPERATIONS AT RATED CONTROL VOLTAGE

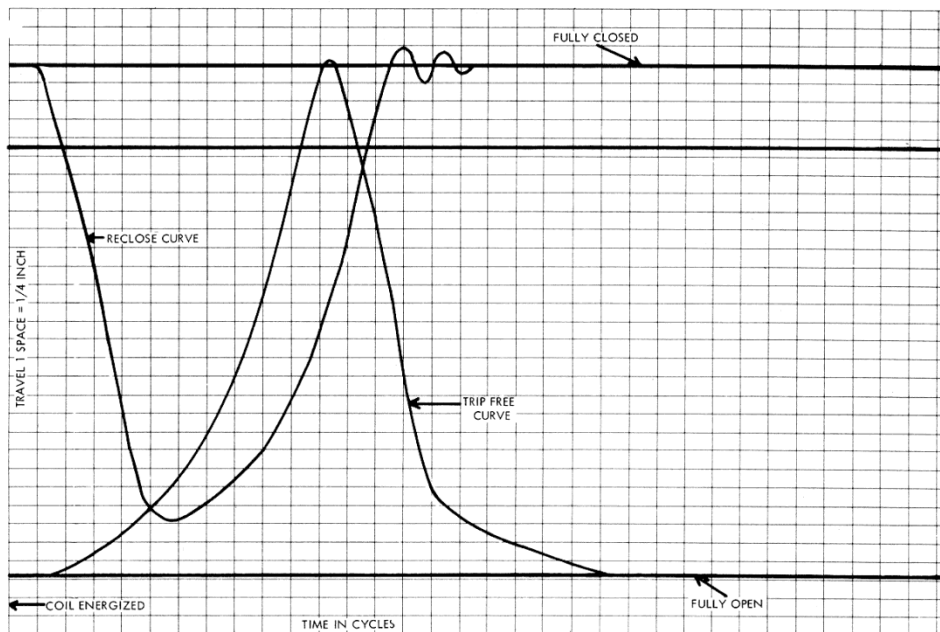

TYPICAL NO LOAD TRAVEL CURVES FOR RECLOSE AND TRIP-FREE OPERATIONS AT RATED CONTROL VOLTAGE

ITE Model 14.4K Circuit Breaker Timing Charts

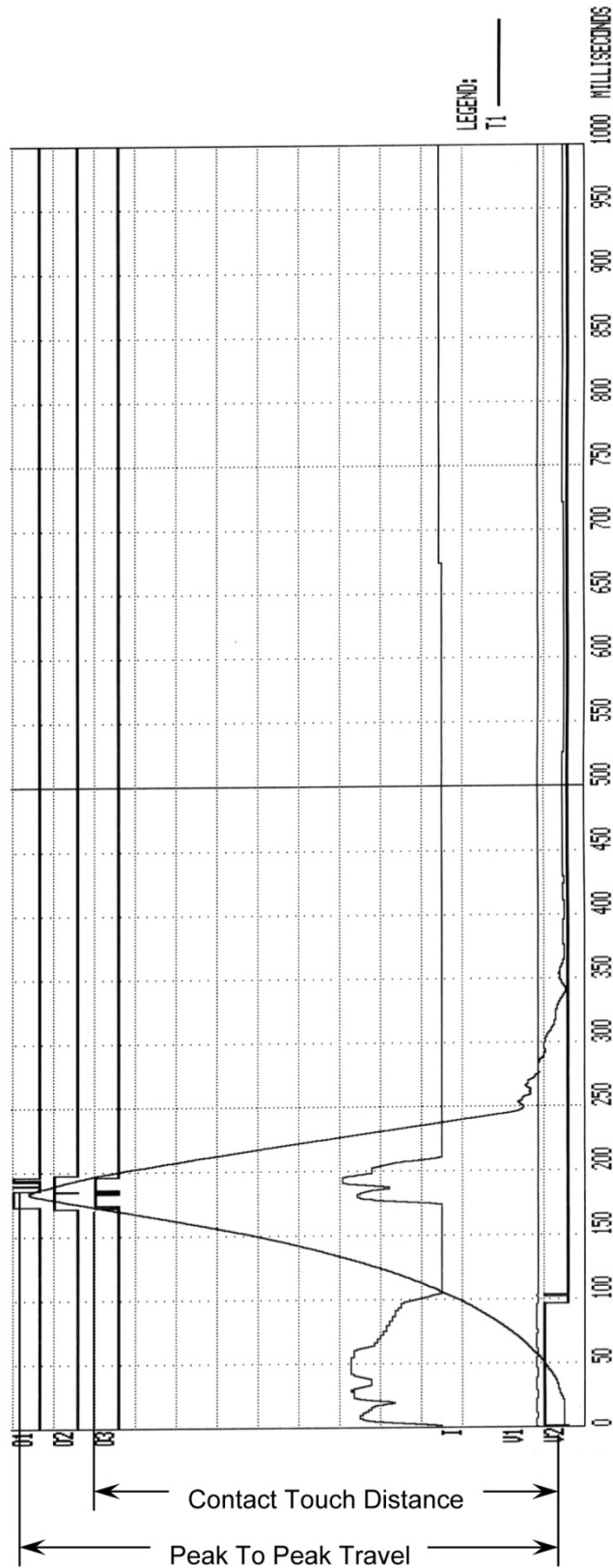

ITE Model 14.4K Circuit Breaker CLOSE-OPEN Timing Chart

BREAKER TIMING RESULTS - 60 Hz			
SHOT NUMBER: 0007			
DATE: 09/01/03 TIME: 13:18:42			
COMPANY: VANGUARD INSTRUMENT			
STATION:			
CIRCUIT:			
MFR:			
MODEL:			
S/N:			
OPERATOR:			
TEST: CLOSE - OPEN			
CONTACT CLOSE TIME			
CH	TIME <ms>	CYCLES	BOUNCE <ms>
1	172.00	10.32	002.50
2	170.70	10.24	000.30
3	170.60	10.24	000.00
CONTACT OPEN TIME			
CH	TIME <ms>	CYCLES	BOUNCE <ms>
1	185.00	11.10	013.40
2	196.70	11.80	000.10
3	000.00	00.00	196.20
CONTACT LIVE TIME			
CH	TIME <ms>	CYCLES	
1	013.00	00.78	
2	026.00	01.56	
3	000.00	00.00	
PEAK TO PEAK TRAVEL <in>			
T1			
07.44			
CH1 TOUCH DISTANCE <in>			
06.49			
V1 NOMINAL VOLTAGE = 48 VOLTS			
V1 MINIMUM VOLTAGE = 45 VOLTS			
INITIATOR CURRENT = 05.6 AMPS			
SHOT LENGTH: 1 SECOND			
INSERTION RESISTOR: NO			
TRIGGER: INTERNAL			
DELAY: CLOSE CH #1			

ITE Model 14.4K Circuit Breaker CLOSE-OPEN Tabulated Report

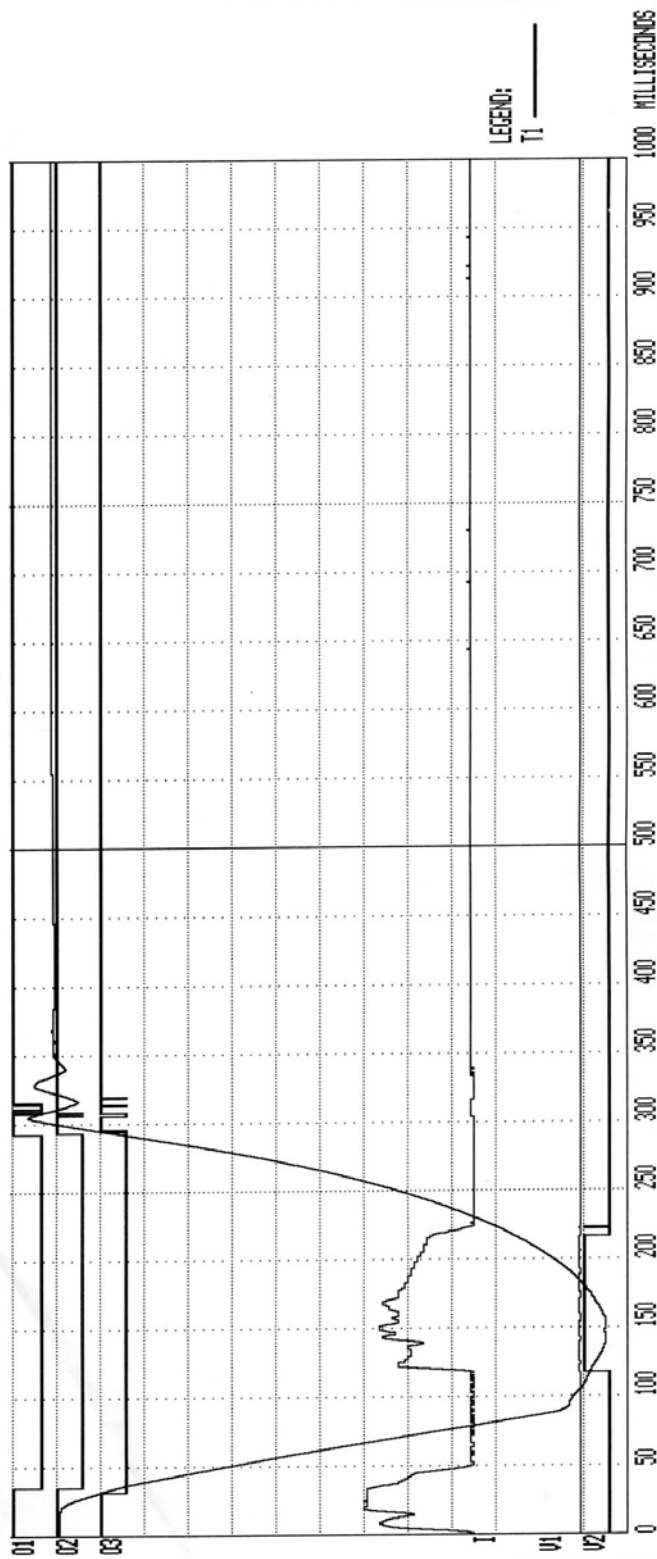

ITE Model 14.4K Circuit Breaker OPEN-CLOSE Timing Chart

BREAKER TIMING RESULTS - 60 Hz			
SHOT NUMBER: 0008			
DATE: 09/01/03		TIME: 13:20:37	
COMPANY: VANGUARD INSTRUMENT			
STATION:			
CIRCUIT:			
MFR:			
MODEL:			
S/N:			
OPERATOR:			
TEST: OPEN - CLOSE			
CONTACT OPEN TIME			
CH	TIME <ms>	CYCLES	BOUNCE <ms>
1	034.30	02.06	001.00
2	034.20	02.05	000.20
3	030.60	01.84	000.70
CONTACT RECLOSE TIME			
CH	TIME <ms>	CYCLES	BOUNCE <ms>
1	291.10	17.47	023.50
2	292.30	17.54	015.60
3	292.80	17.57	025.80
CONTACT DEAD TIME			
CH	TIME <ms>	CYCLES	
1	256.80	15.41	
2	258.10	15.49	
3	262.20	15.73	
PEAK TO PEAK TRAVEL <in>			
T1			
07.21			
V1 NOMINAL VOLTAGE = 48 VOLTS			
V1 MINIMUM VOLTAGE = 47 VOLTS			
INITIATOR CURRENT = 05.7 AMPS			
SHOT LENGTH:		1 SECOND	
INSERTION RESISTOR:		NO	
TRIGGER:		INTERNAL	
DELAY:		100 ms	

ITE Model 14.4K Circuit Breaker OPEN-CLOSE Tabulated Report

5.2 APPENDIX B – Siemens TCP Breaker Velocity Calculation

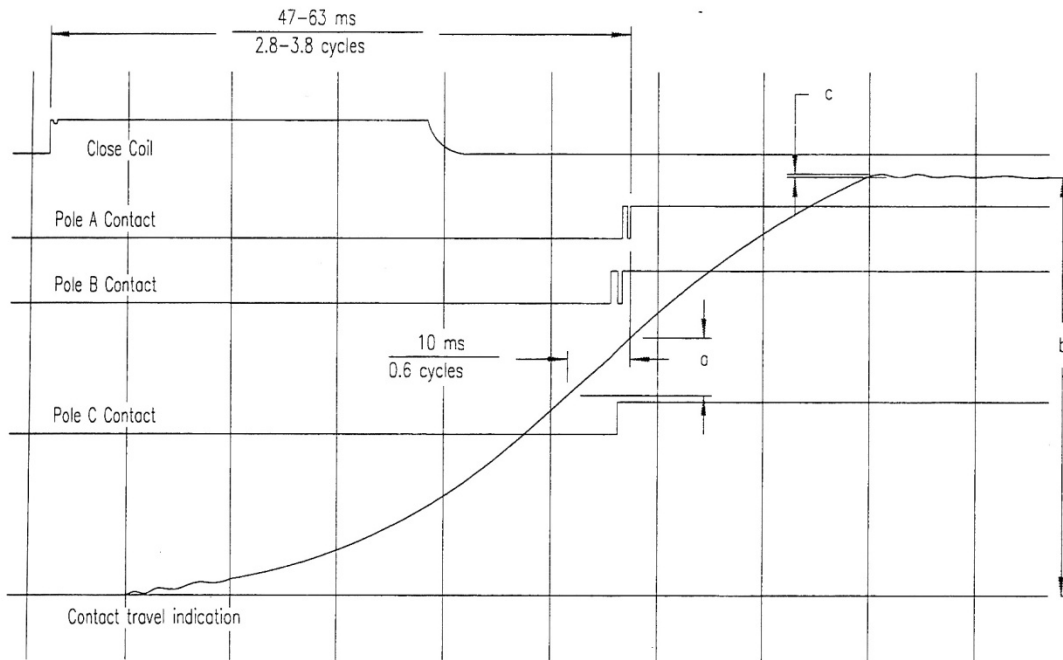

Example of Close Operation Record

Calculation For Contact Closing Velocity

$$V=12.0a/b \text{ meters/second}$$

Calculation For Overtravel/rebound

$$S=120.0c/b \text{ millimeters}$$

Note: a,b and c may be measured in any consistent units

Contact Stroke = 120 mm
 Transducer Stroke = 80 mm

5.3 APPENDIX C – Siemens SPS2 Breaker Velocity Calculation

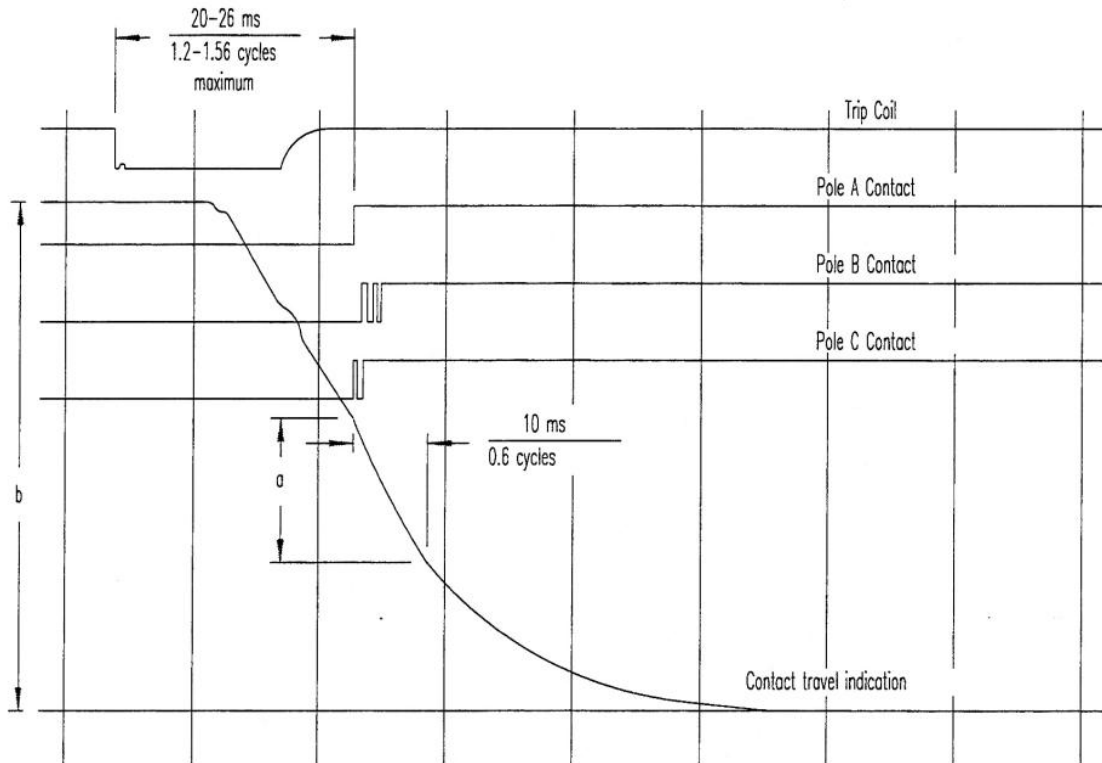

Example of Opening Operation Record

Calculation For Contact Opening Velocity

$$V = 12.0a/b \text{ meter/second}$$

Note: a,b and may be measured in any consistant units

Contact Stroke = 120mm
Transducer Stroke = 80 mm

<http://www.siemens.com>

5.4 APPENDIX D – CT-8000 S3 Test Plan for Siemens SPS2

TEST PLAN NUMBER 1				
MFR: SPS2 121				
TYPE: Siemens				
COMMENT:				
CONTACT TIME PARAMETERS				
		OPEN	CLOSE	
MAX Δ msV		026.0	069.0	
MIN Δ msV		020.0	047.0	
DELTA LIM Δ msV		004.0	004.0	
O-I, O-I-O PARAMS: LIVE DEAD				
MAX Δ msV		040.0	200.0	
MIN Δ msV		020.0	150.0	
RESISTOR ON-TIME PARAMETERS				
		OPEN	CLOSE	
MAX Δ msV		000.0	000.0	
MIN Δ msV		000.0	000.0	
DELTA LIM Δ msV		000.0	000.0	
O-I, O-I-O PARAMS: LIVE DEAD				
MAX Δ msV		000.0	000.0	
MIN Δ msV		000.0	000.0	
TRAVEL PARAMETERS				
	STRK	VEL	O-TUL	BNC-BK
	mm	M/S	mm	mm
OPEN HI	085.1	04.90	003.0	003.0
OPEN LOW	074.9	04.20	000.0	000.0
CLOSE HI	085.1	04.50	004.1	004.1
CLOSE LD	074.9	03.50	000.0	000.0
VEL = CXCIDISTKAP1 - AP2V/STROKEJ				
C = 12.00 M/S				
OPEN SPEED ANALYSIS POINTS:				
POINT 1 = CONTACT				
POINT 2 = CONTACT PLUS 010.0 ms				
CLOSE SPEED ANALYSIS POINTS:				
POINT 1 = CONTACT				
POINT 2 = CONTACT MINUS 010.0 ms				

5.5 APPENDIX E – CT-8000 S3 Transducer Illustrations



Linear Transducer on an OCB



Rotary Transducer on Alstom HE 1014 Circuit Breaker



Rotary Transducer on ABB HMB Mechanism



Rotary Transducer on Federal Pacific Circuit Breaker



Resistor Transducer on Vacuum Circuit Breaker

5.6 APPENDIX F – CT-8000 S3 Accessories



**ON-LINE
TIMING PROBES**
part no 9103-OT



**DUAL GROUND
PROBES
(3 probes)**
part no 9103-DG



**LINEAR
TRANSDUCERS**
10" part no 9087-UC
25" part no 9088-UC



**ROTARY
TRANSDUCER
WITH
MAGNETIC
MOUNT**
part no 9091-UC



**ROTARY
TRANSDUCER**
part no 9090-UC



**RESISTOR-TYPE
TRANSDUCER**
part no 9093-UC



**ABB AHMA-8
mechanism
transducer**
Part no 9085-UC



DOBLE TRANSDUCER ADAPTER

Part no 9084-UC

The Doble Transducer Adapter can be used to interface any Doble travel transducer to a Vanguard circuit breaker analyzer.

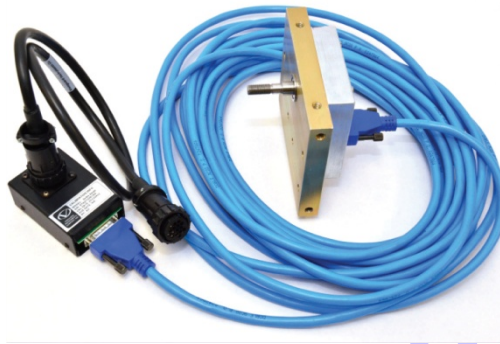

Connected to Doble rotary transducer

<http://www.51082245.com>



**Vanguard Instruments
Company, Inc.**

1520 S. Hellman Ave • Ontario, CA 91761 • USA

Phone: 909-923-9390 • Fax: 909-923-9391

www.vanguard-instruments.com

Copyright © 2013 by Vanguard Instruments Company, Inc.

CT-8000 S3 User's Manual • Revision 1.0 • October 10, 2013 • TA